

**FRONT VIEW**

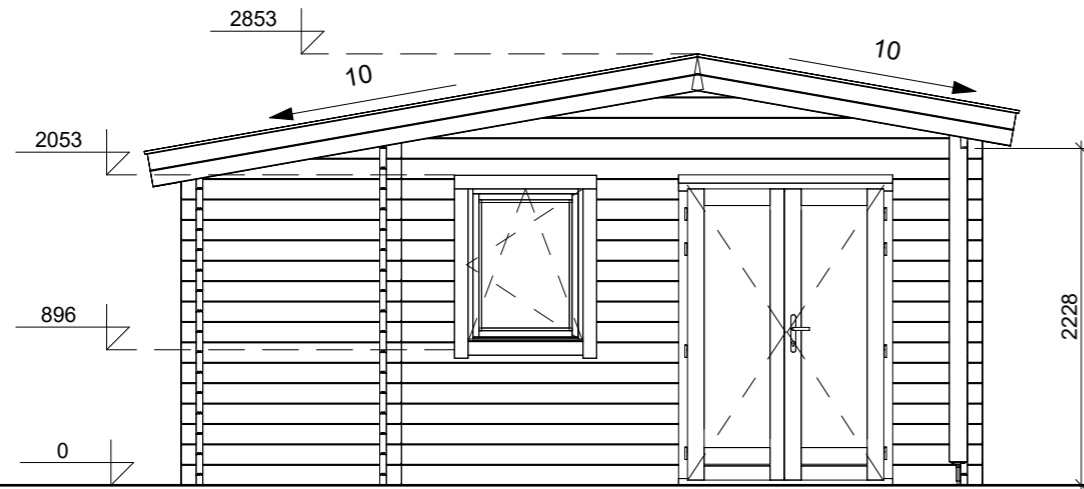

**LEFT SIDE VIEW**

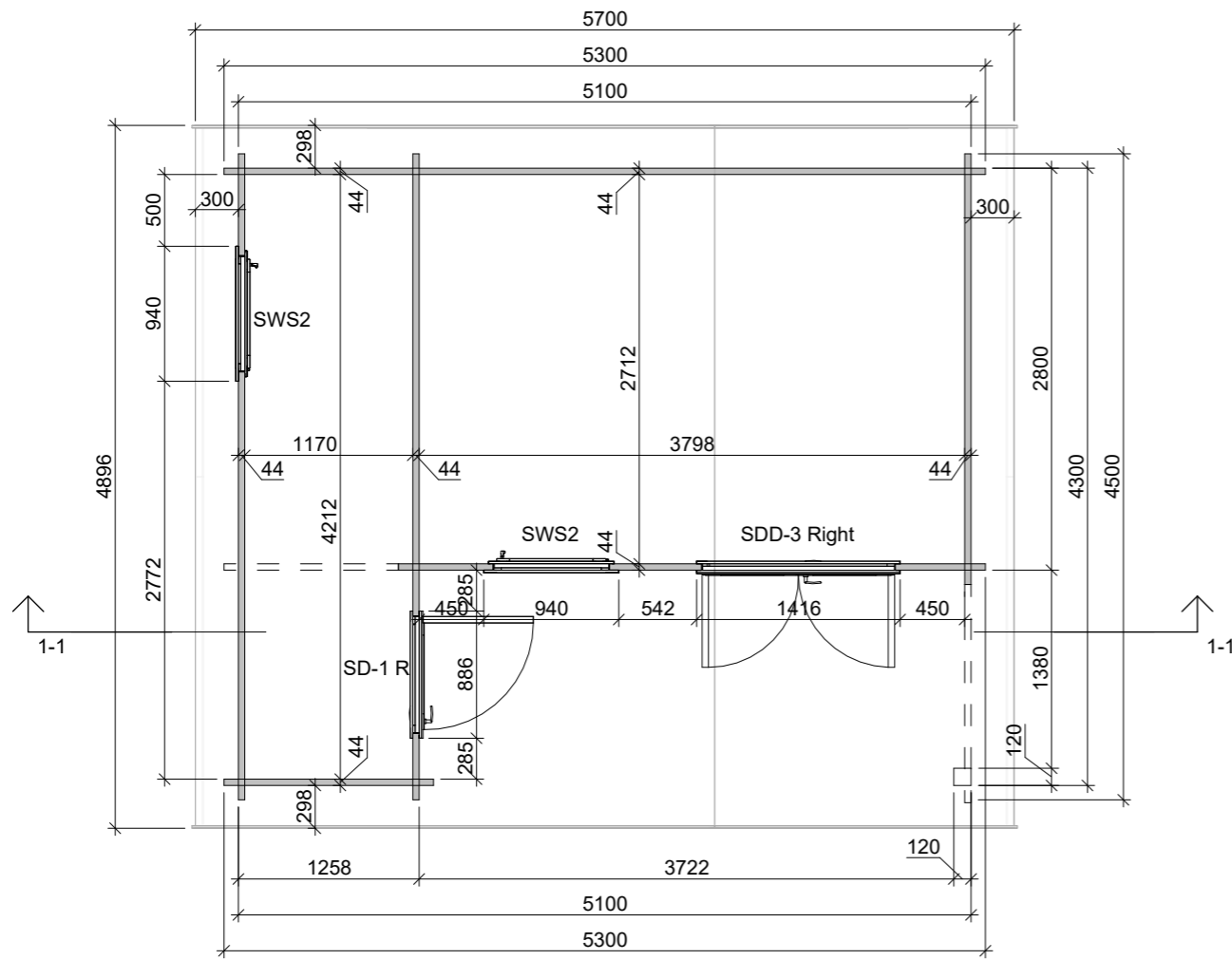

**FLOOR PLAN**

**SECTION 1-1**

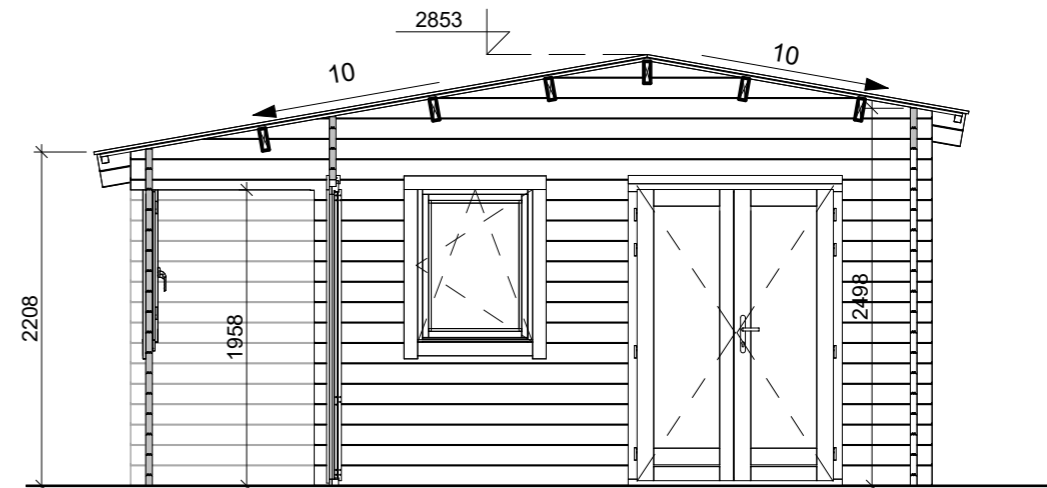

|   |        |        |           |                        |
|---|--------|--------|-----------|------------------------|
| Project Nr. <b>334-08-22HW Log cabin 450x530cm 44mm</b> |        |        |           |                        |
| ARCHITECTURE<br>DRAWINGS                                | Scale  | Drawer | Sheet Nr. | Date                   |
|   | 1 : 50 | RB     | AR - 1    | 07.12.2022<br>11:14:30 |

**REAR VIEW**

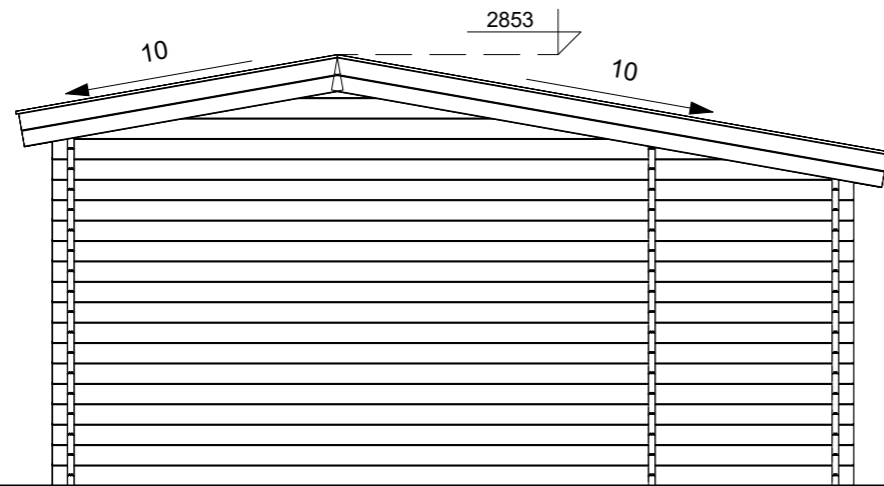

**RIGHT SIDE VIEW**

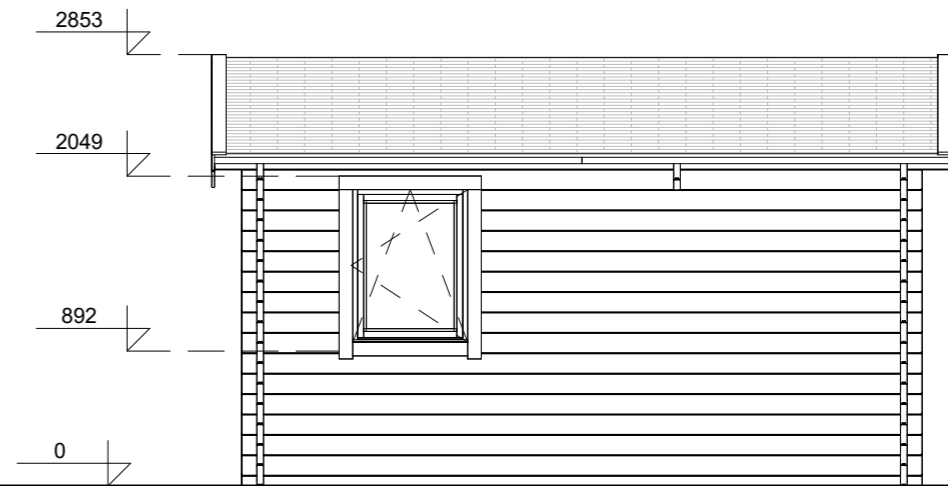

**3D VIEW**

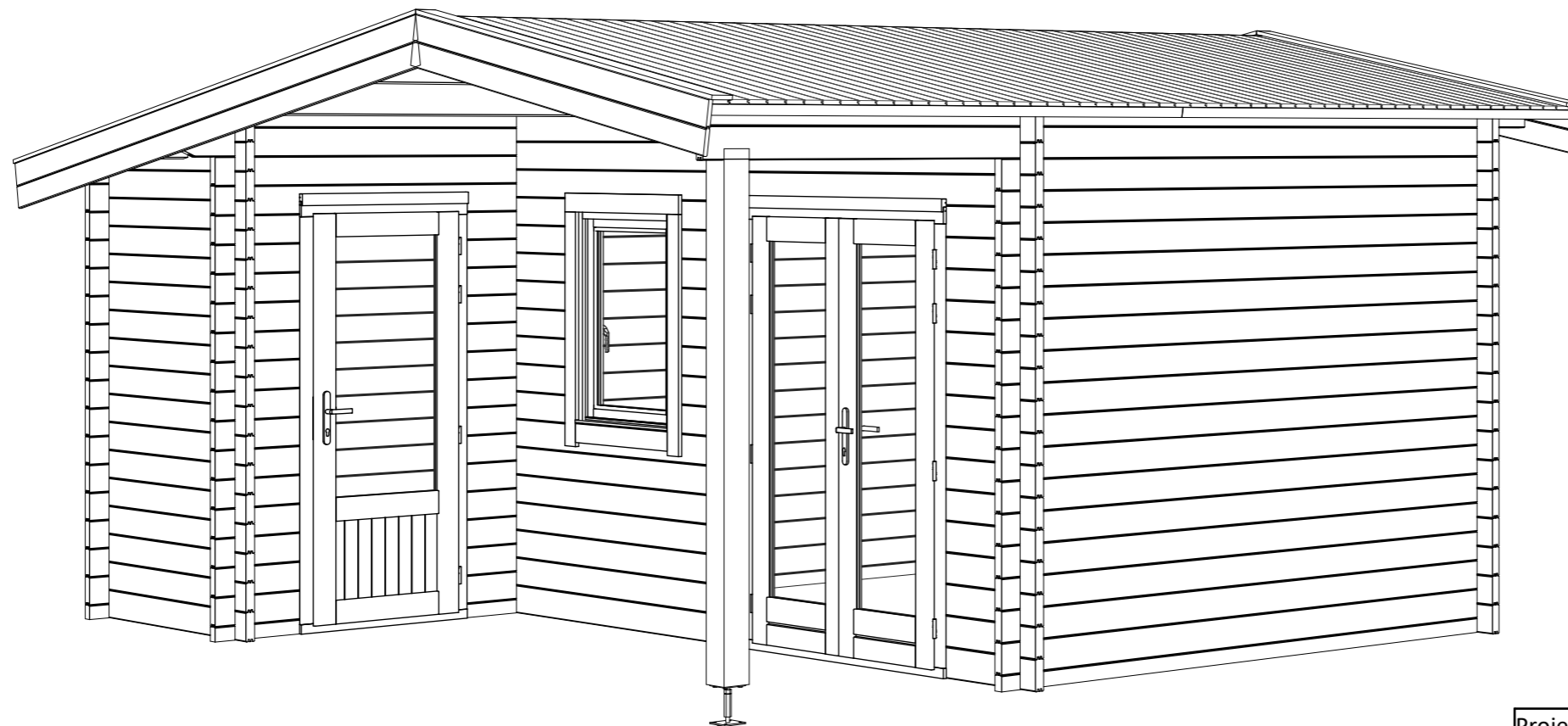



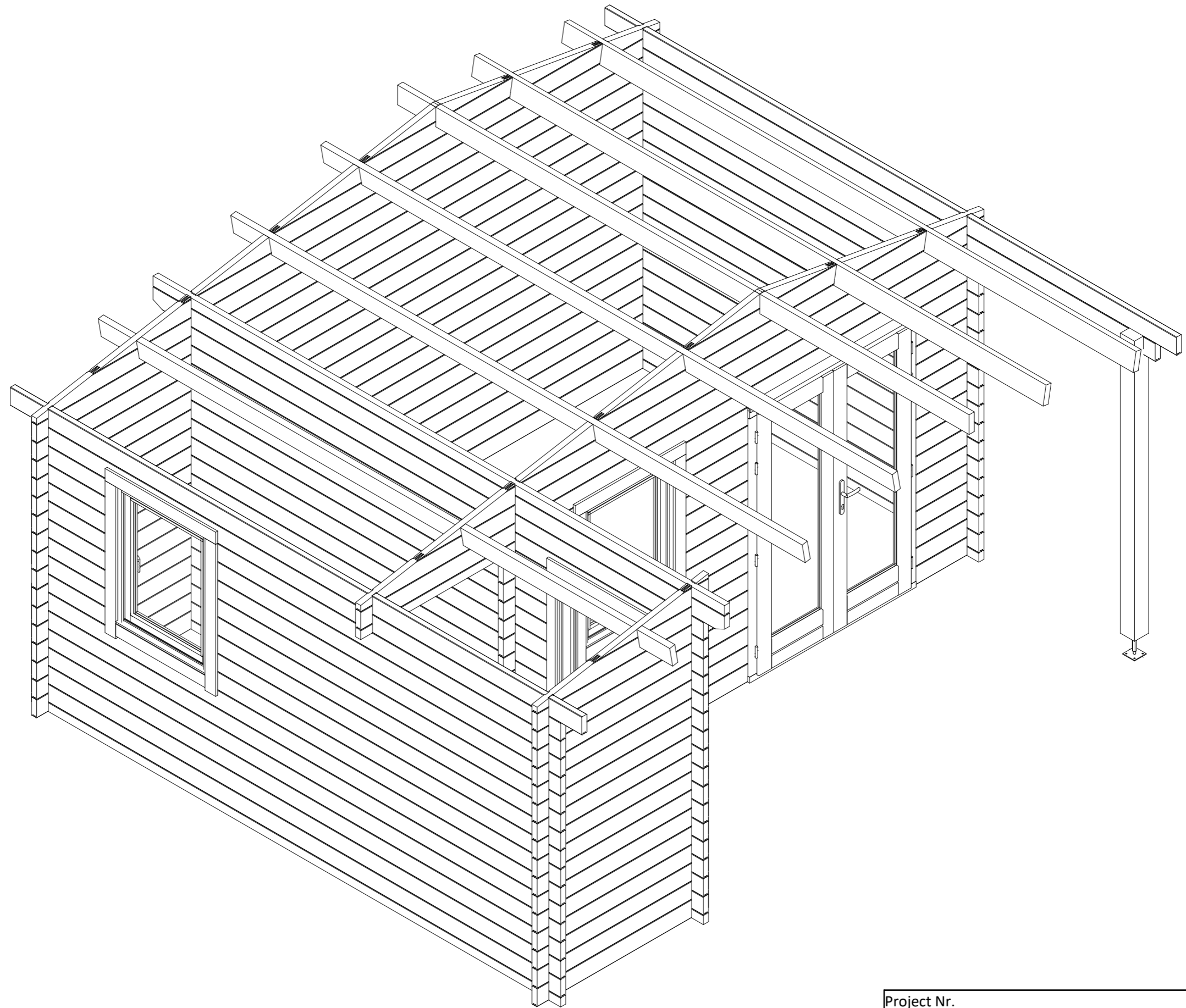

|   |        |        |           |                        |
|---|--------|--------|-----------|------------------------|
| Project Nr. <b>334-08-22HW Log cabin 450x530cm 44mm</b> |        |        |           |                        |
| ARCHITECTURE<br>DRAWINGS                                | Scale  | Drawer | Sheet Nr. | Date                   |
|   | 1 : 50 | RB     | AR - 2    | 07.12.2022<br>11:14:32 |

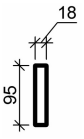

|   |       |        |           |                        |
|---|-------|--------|-----------|------------------------|
| Project Nr. <b>334-08-22HW Log cabin 450x530cm 44mm</b> |       |        |           |                        |
| ARCHITECTURE<br>DRAWINGS                                | Scale | Drawer | Sheet Nr. | Date                   |
|   |       | RB     | AR - 3    | 07.12.2022<br>11:14:33 |

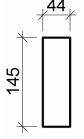
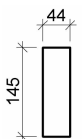
### ROOF PART SPECIFICATION

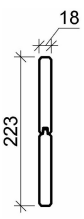
| Type Image   | Keynote     | Description           |
|--|-------------|-----------------------|
|   | CB 18x95    | Cover board           |
|   | RB 18x88    | Roof board 18mm       |
|   | RJ 44x145-1 | Roof joist 44x145     |
|   | RJ 44x145-2 | Roof joist 44x145     |
|   | RS 44x44    | Roof side board 44x44 |
|  | WB 18mm     | Wind board 18mm       |

### FLOOR PART SPECIFICATION

| Type Image | Keynote | Description |
|------------|---------|-------------|
|------------|---------|-------------|

### DOOR SCHEDULE

| Keynote     | Count |
|-------------|-------|
| SD-1 R      | 1     |
| SDD-3 Right | 1     |
|             | 2     |

### WINDOW SCHEDULE

| Keynote | Count |
|---------|-------|
| SWS2    | 2     |
|         | 2     |

### ROOF SCHEDULE

| Roof type | Area              |
|-----------|-------------------|
| Apex      | 28 m <sup>2</sup> |
|           | 28 m <sup>2</sup> |

### FLOOR SCHEDULE

| Description | Area |
|-------------|------|
|-------------|------|

Project Nr.

**334-08-22HW Log cabin 450x530cm 44mm**

ARCHITECTURE  
DRAWINGS

Scale

Drawer

Sheet Nr.

Date

RB

AR - 4

07.12.2022  
11:14:33

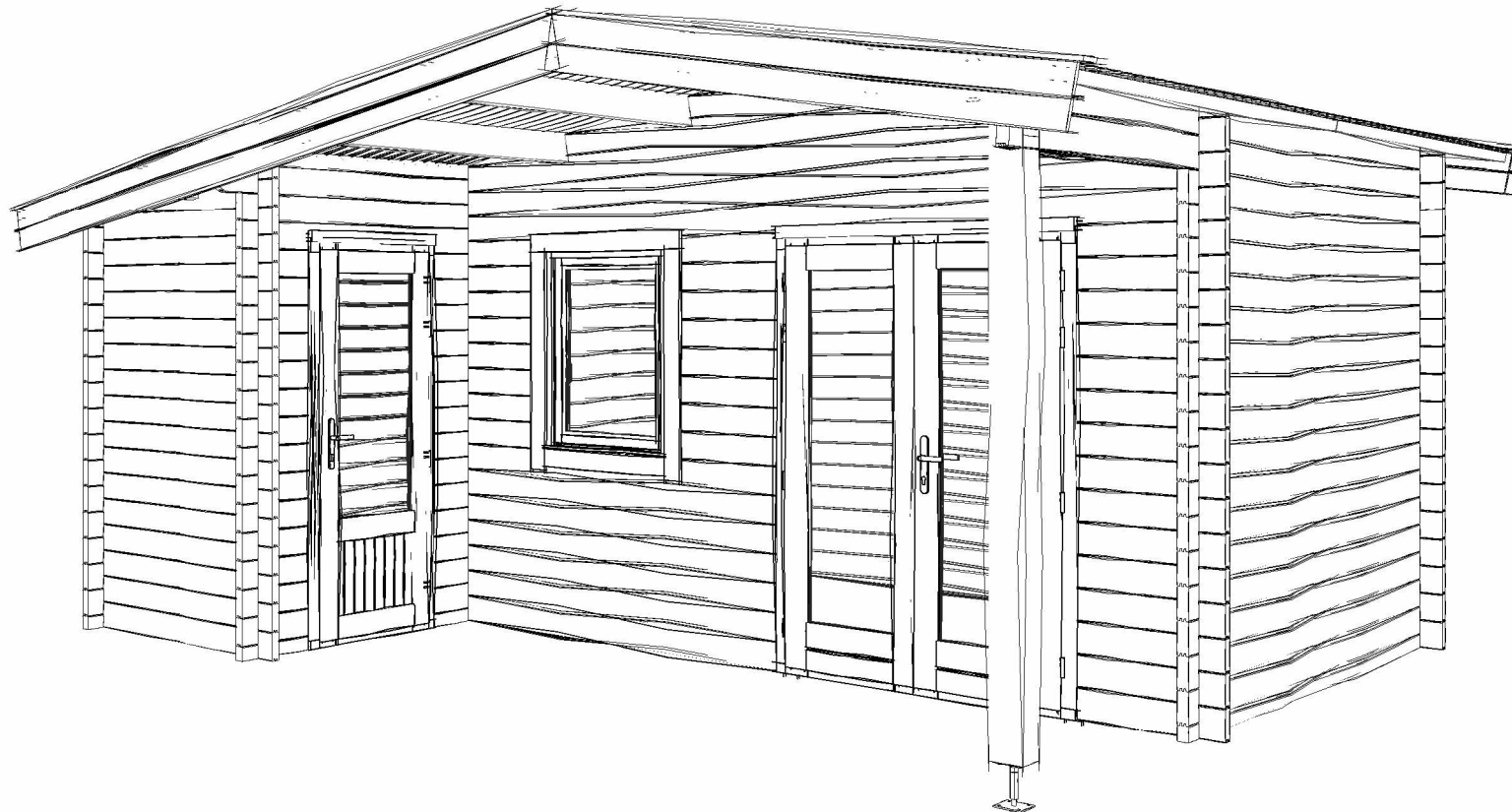

***334-08-22HW Log cabin  
450x530cm 44mm***

-

|                    |               |   |           |                        |
|--------------------|---------------|---|-----------|------------------------|
| Project Nr.        |               | <b>334-08-22HW Log cabin 450x530cm 44mm</b> |           |                        |
| Dealer             | -             | COVER PAGE                                  |           | Scale                  |
| Dealers references | -             |   |           | Date                   |
|                    | <b>Berlin</b> | Drawer                                      | Sheet Nr. | Date                   |
|                    | -             | RB  | TD        | 07.12.2022<br>11:11:10 |

## Wall logs

| Log thickness | Log height | Cut Length | Count |
|---------------|------------|------------|-------|
| 44 mm         | 135 mm     | 3000       | 17    |
| 44 mm         | 135 mm     | 4500       | 1     |
| 44 mm         | 135 mm     | 4860       | 1     |

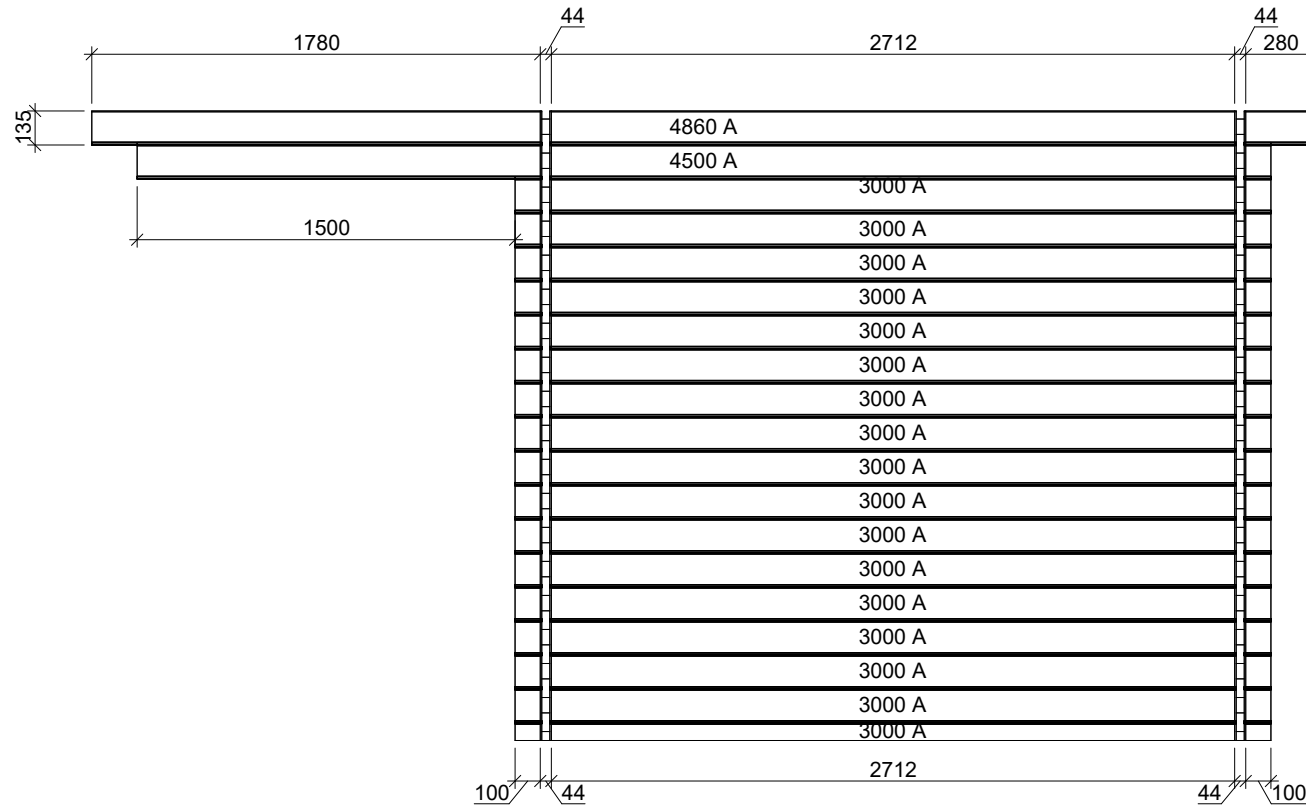

|   |               |           |                        |
|---|---------------|-----------|------------------------|
| Project Nr.                                 |               |           |                        |
| <b>334-08-22HW Log cabin 450x530cm 44mm</b> |               |           |                        |
| Dealer                                      | -             | Wall logs | Scale                  |
| Dealers references                          | -             |           | 1 : 30                 |
|   | <b>Berlin</b> | Drawer    | Sheet Nr.              |
|   | -             | RB        | WALL - A               |
|   | -             |           | Date                   |
|   | -             |           | 07.12.2022<br>11:11:11 |



## Wall logs

| Log thickness | Log height | Cut Length | Count |
|---------------|------------|------------|-------|
| 44 mm         | 135 mm     | 709        | 7     |
| 44 mm         | 135 mm     | 2981       | 7     |
| 44 mm         | 135 mm     | 4500       | 9     |
| 44 mm         | 135 mm     | 4860       | 1     |

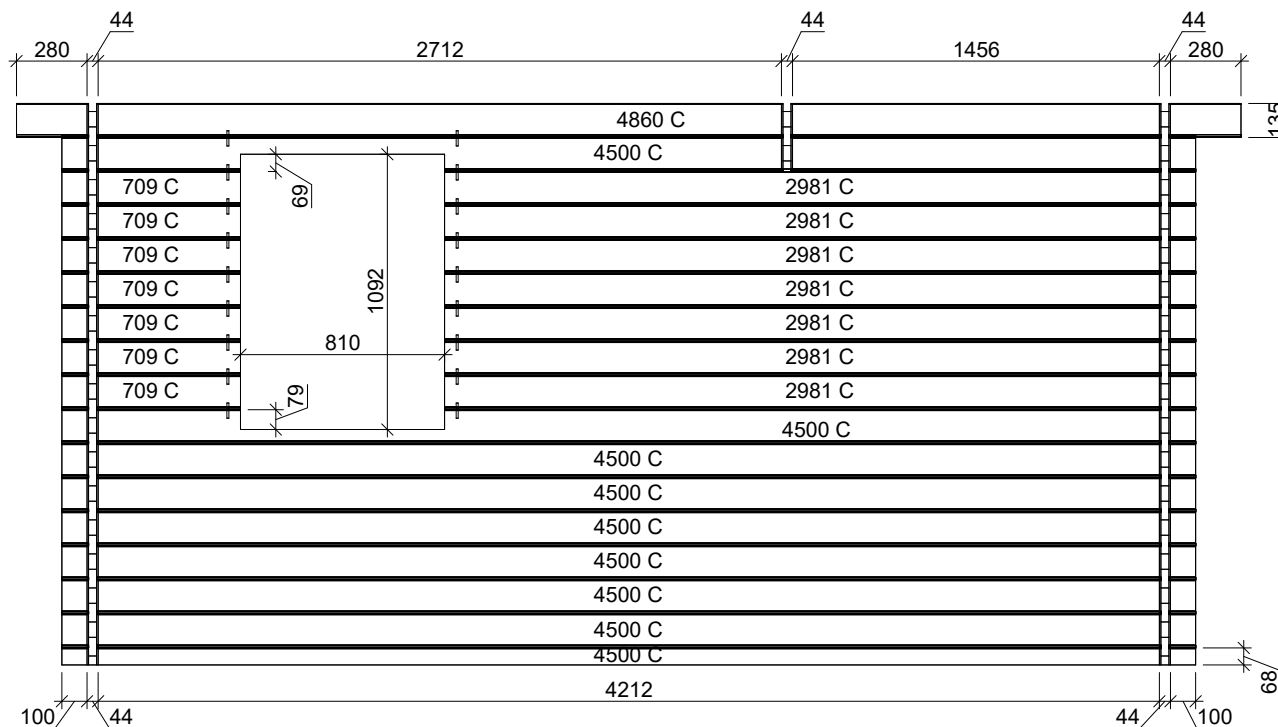

|   |               |                        |           |
|---|---------------|------------------------|-----------|
| Project Nr. <b>334-08-22HW Log cabin 450x530cm 44mm</b> |               |                        |           |
| Dealer  | -             | Wall logs              |           |
| Scale   |               |                        |           |
| Dealers references                                      | -             | Drawer                 | Sheet Nr. |
|   | <b>Berlin</b> | RB                     | WALL - C  |
|   | -             | Date                   |           |
|   |               | 07.12.2022<br>11:11:11 |           |



## Wall logs

| Log thickness | Log height | Cut Length | Count |
|---------------|------------|------------|-------|
| 44 mm         | 135 mm     | 206        | 1     |
| 44 mm         | 135 mm     | 971        | 1     |
| 44 mm         | 135 mm     | 1458       | 17    |

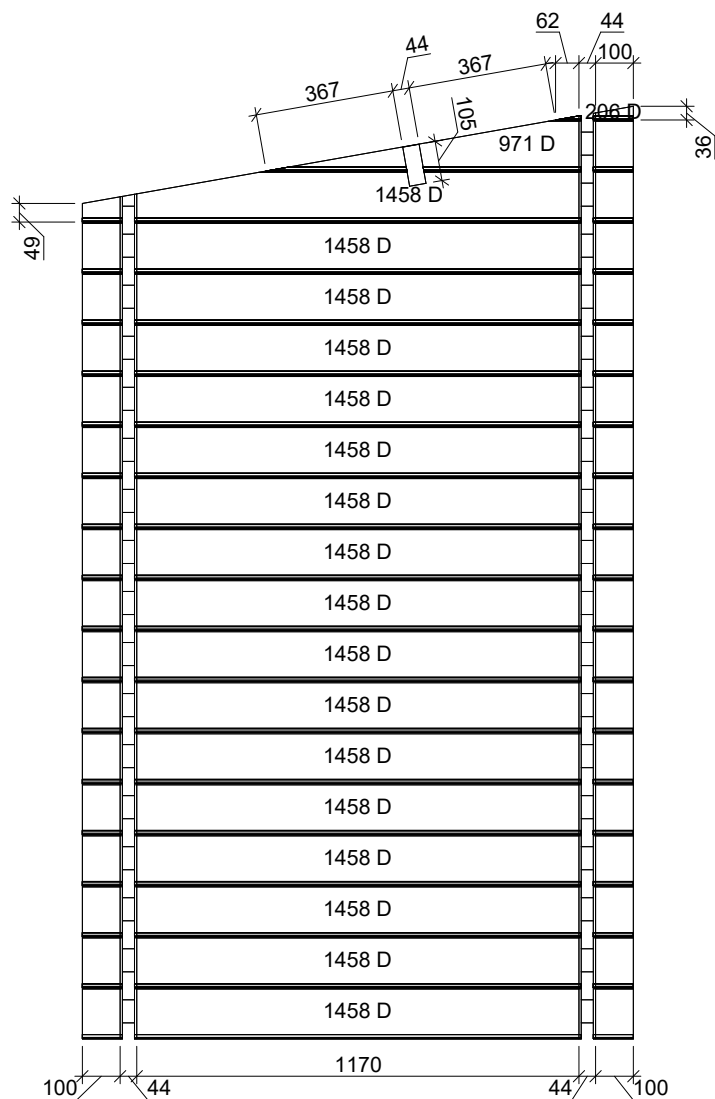

|   |               |           |                        |
|---|---------------|-----------|------------------------|
| Project Nr.                                 |               |           |                        |
| <b>334-08-22HW Log cabin 450x530cm 44mm</b> |               |           |                        |
| Dealer                                      | -             | Scale     |                        |
| Dealers references                          | -             | Wall logs |                        |
|   |               | Drawer    | Sheet Nr.              |
|   | <b>Berlin</b> | RB        | WALL - D               |
|   | -             |           | Date                   |
|   |               |           | 07.12.2022<br>11:11:12 |

## Wall logs

| Log thickness | Log height | Cut Length | Count |
|---------------|------------|------------|-------|
| 44 mm         | 135 mm     | 462        | 15    |
| 44 mm         | 135 mm     | 3218       | 15    |
| 44 mm         | 135 mm     | 4500       | 2     |
| 44 mm         | 135 mm     | 4860       | 2     |

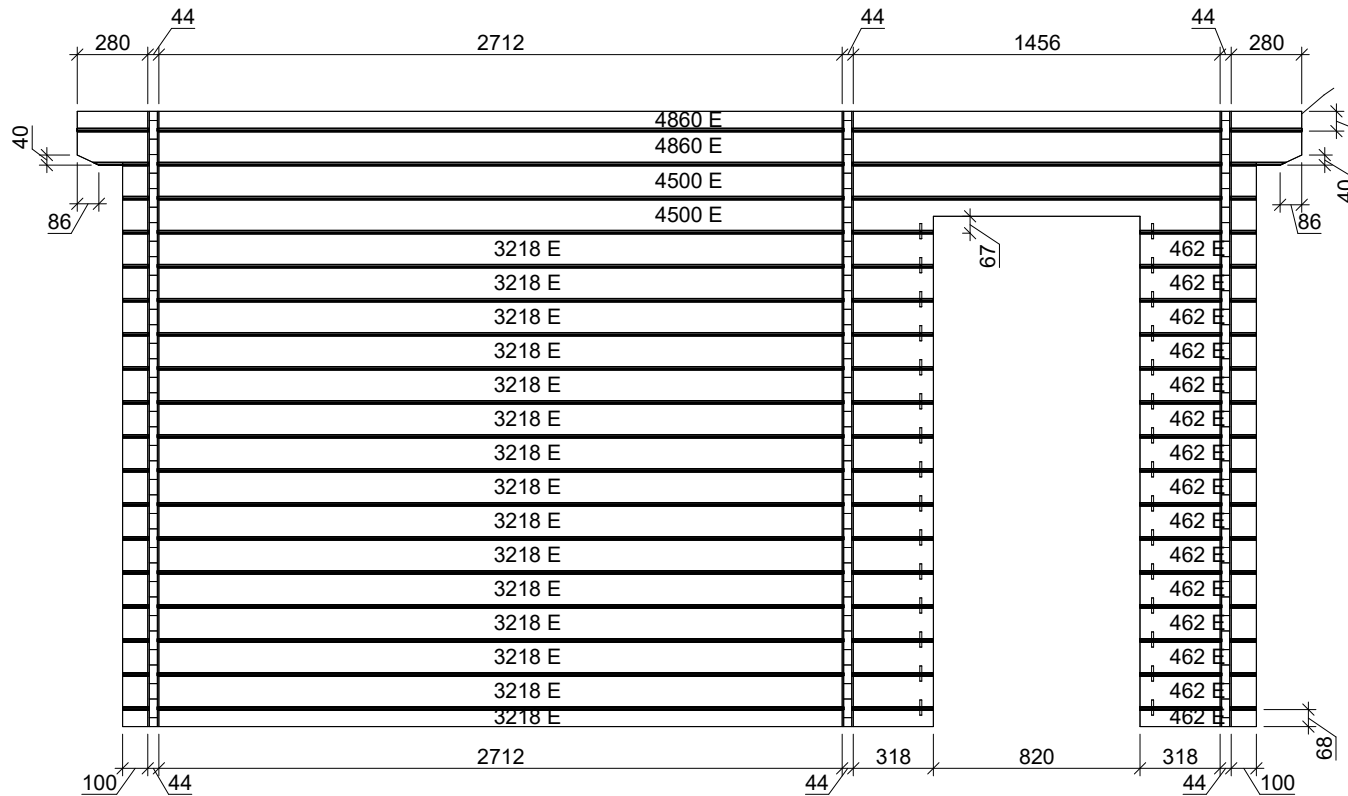

Veidot rādusu 3mm

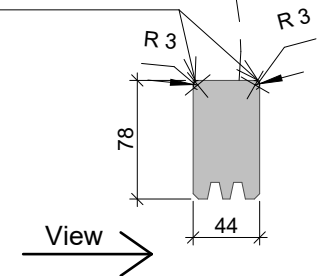

|   |               |           |                        |
|---|---------------|-----------|------------------------|
| Project Nr.                                 |               |           |                        |
| <b>334-08-22HW Log cabin 450x530cm 44mm</b> |               |           |                        |
| Dealer                                      | -             | Wall logs |                        |
| Dealers references                          | -             | Scale     | As indicated           |
|   | <b>Berlin</b> | Drawer    | Sheet Nr.              |
|   | -             | RB        | WALL - E               |
|   | -             | Date      | 07.12.2022<br>11:11:12 |

## Wall logs

| Log thickness | Log height | Cut Length | Count |
|---------------|------------|------------|-------|
| 44 mm         | 135 mm     | 627        | 15    |
| 44 mm         | 135 mm     | 640        | 8     |
| 44 mm         | 135 mm     | 659        | 7     |
| 44 mm         | 135 mm     | 1265       | 1     |
| 44 mm         | 135 mm     | 1873       | 1     |
| 44 mm         | 135 mm     | 2109       | 7     |
| 44 mm         | 135 mm     | 2796       | 1     |
| 44 mm         | 135 mm     | 4048       | 1     |
| 44 mm         | 135 mm     | 4813       | 1     |
| 44 mm         | 135 mm     | 5300       | 2     |

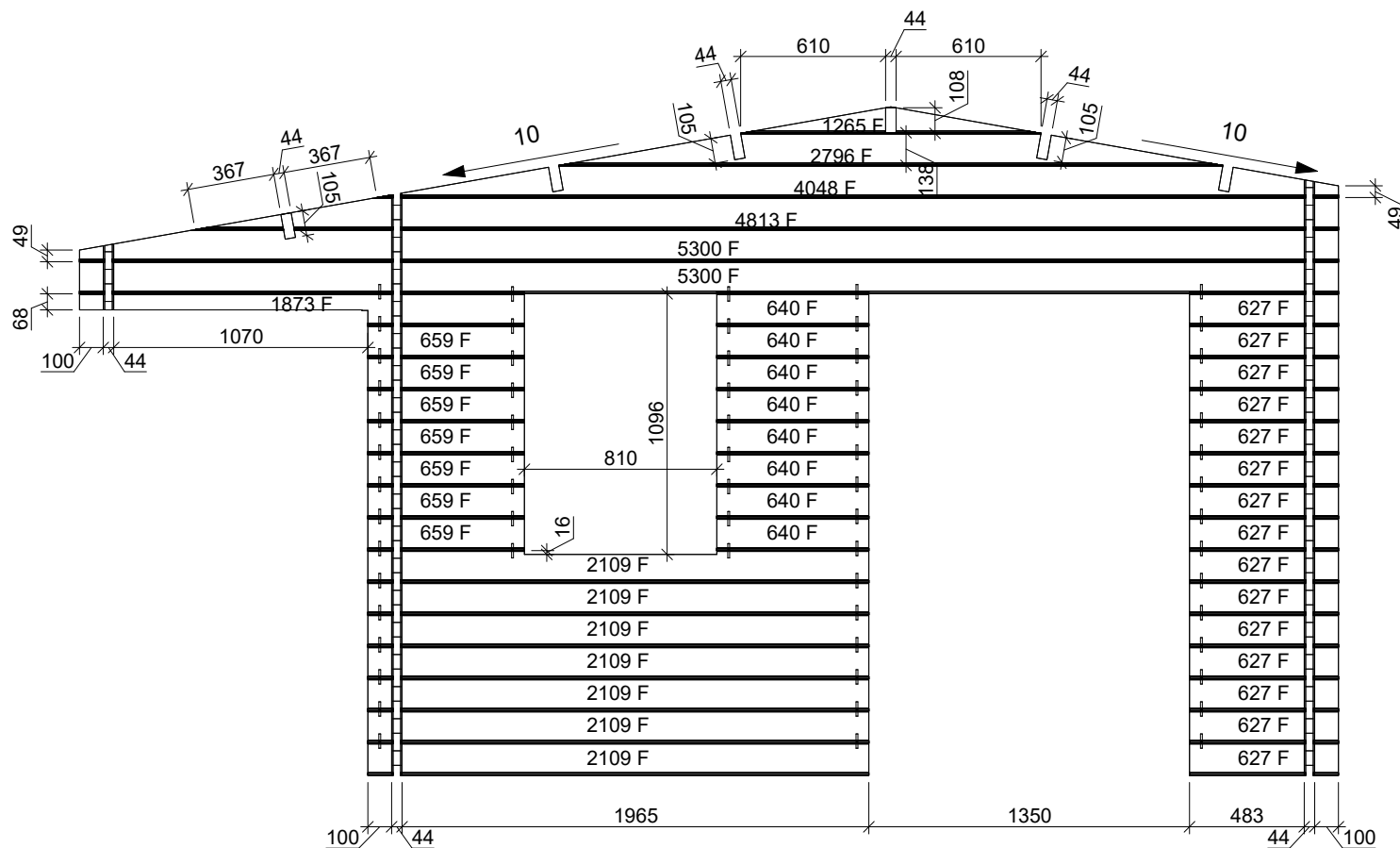

|   |               |           |                        |
|---|---------------|-----------|------------------------|
| Project Nr.                                 |               |           |                        |
| <b>334-08-22HW Log cabin 450x530cm 44mm</b> |               |           |                        |
| Dealer                                      | -             | Wall logs | Scale                  |
| Dealers references                          | -             |           | 1 : 30                 |
|   | <b>Berlin</b> | Drawer    | Sheet Nr.              |
|   | -             | RB        | WALL - F               |
|   | -             |           | Date                   |
|   | -             |           | 07.12.2022<br>11:11:12 |

## LOG WALL NUMBERING

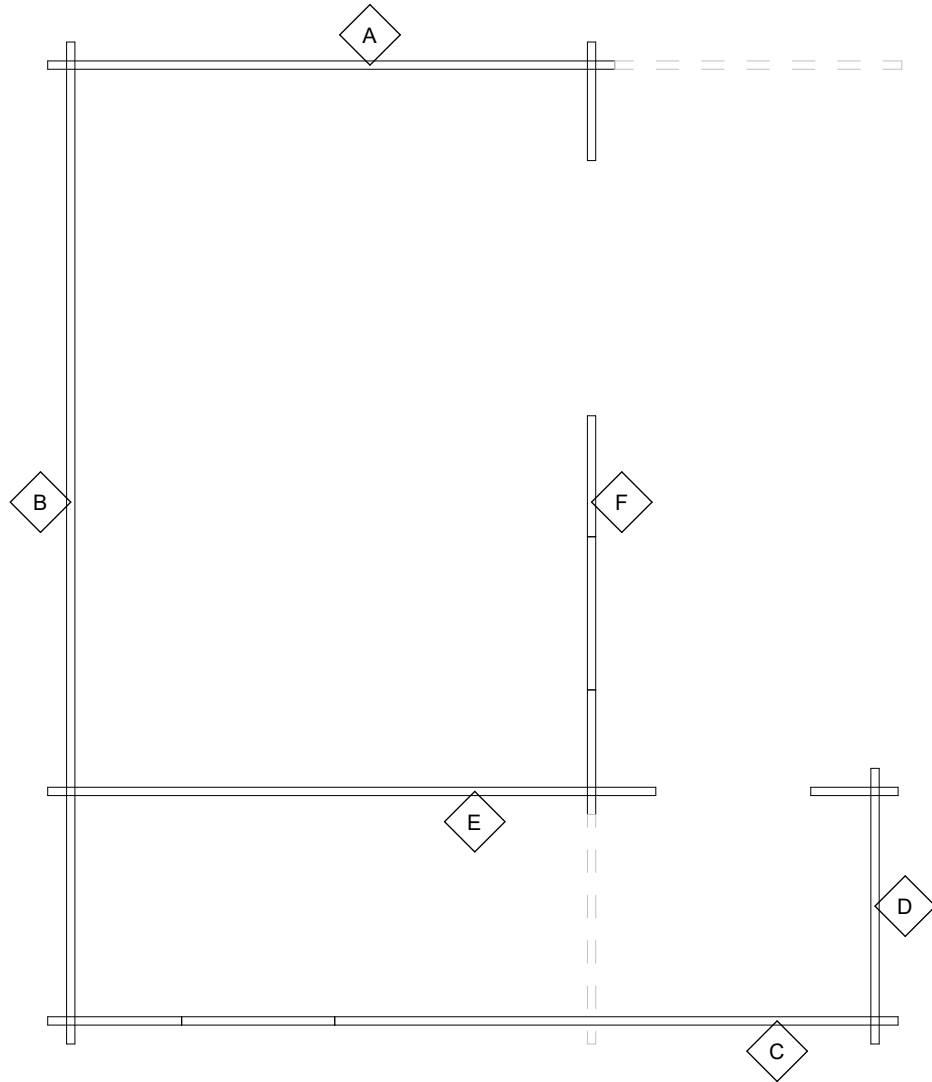

## LOG WALL 3D VIEW

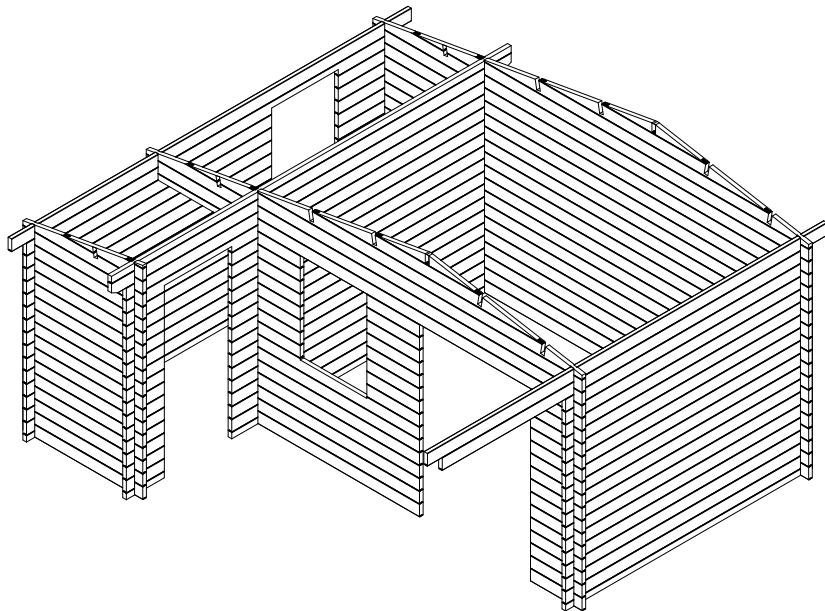

|   |               |                    |                        |
|---|---------------|--------------------|------------------------|
| Project Nr.                                 |               |                    |                        |
| <b>334-08-22HW Log cabin 450x530cm 44mm</b> |               |                    |                        |
| Dealer                                      | -             | LOG WALL POSITIONS | Scale                  |
| Dealers references                          | -             |                    | 1 : 40                 |
|   | <b>Berlin</b> | Drawer             | Sheet Nr.              |
|   | -             | RB                 | TD-1                   |
|   | -             |                    | 07.12.2022<br>11:11:13 |

## Post detail views

Top view

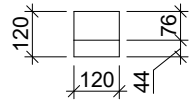

Front view

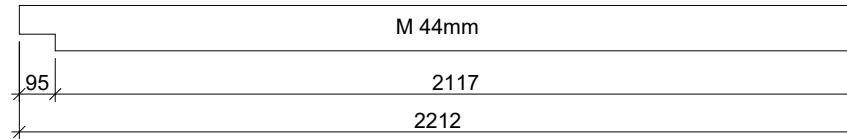

### POST SCHEDULE

| Keynote | Description  | Length | Count | Volume               |
|---------|--------------|--------|-------|----------------------|
| M 44mm  | Post 120x120 | 2212   | 1     | 0.031 m <sup>3</sup> |
|         |              |        |       | 0.031 m <sup>3</sup> |

|   |               |                                    |           |
|---|---------------|------------------------------------|-----------|
| Project Nr.                                 |               |                                    |           |
| <b>334-08-22HW Log cabin 450x530cm 44mm</b> |               |                                    |           |
| Dealer                                      | -             | POST SCHEDULES AND<br>DETAIL VIEWS |           |
|   | -             |                                    |           |
| Dealers references                          | -             | Drawer                             | Sheet Nr. |
|   | <b>Berlin</b> | RB                                 | TD-2      |
|   | -             | Date                               |           |
|   |               | 07.12.2022<br>11:11:13             |           |

# ROOF PARTS PLAN

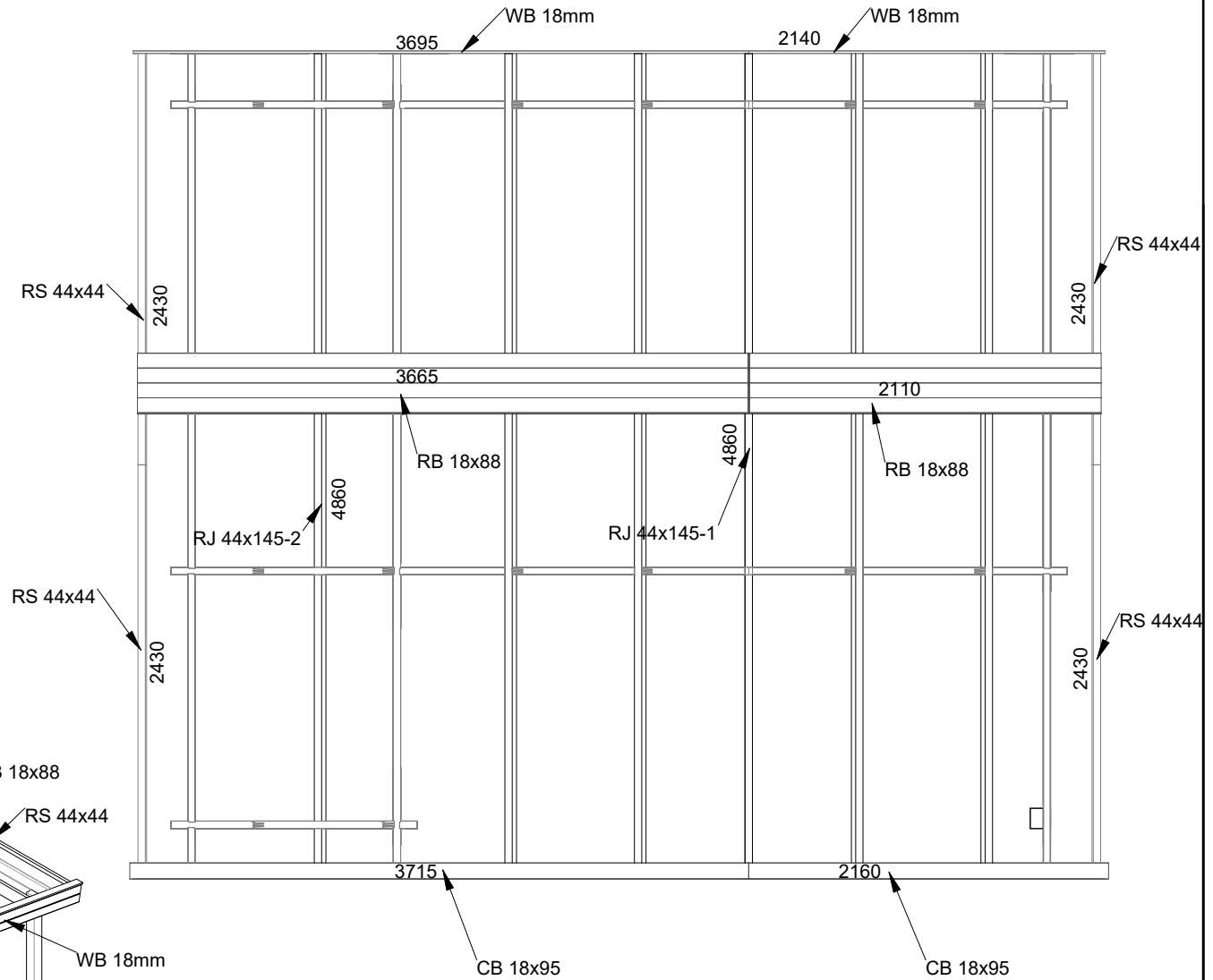



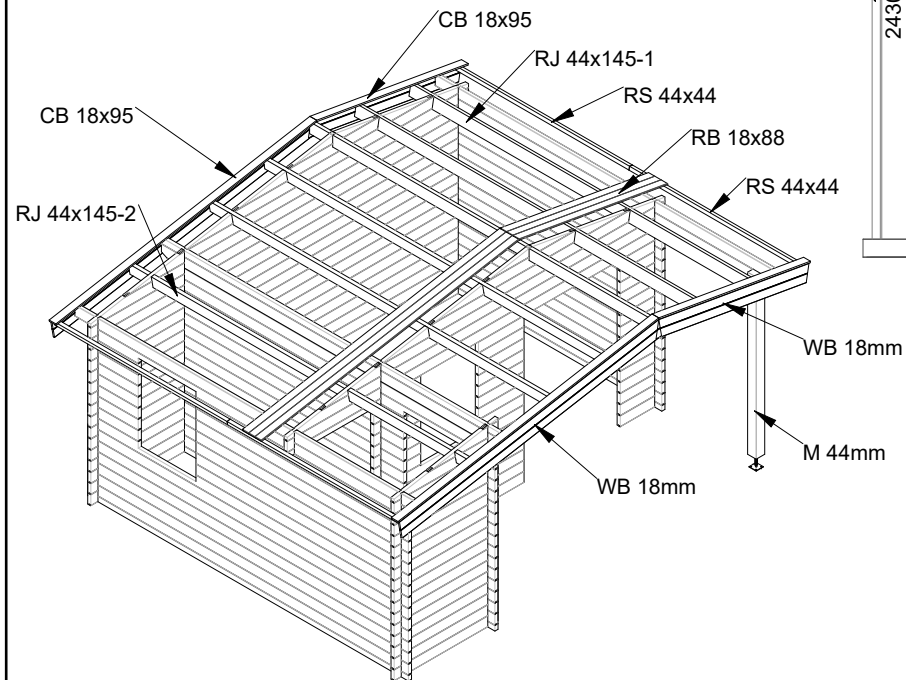

# ROOF PARTS ASSEMBLY VIEW

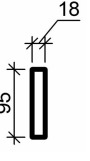
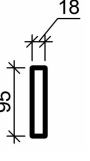

|   |               |                 |                                |
|---|---------------|-----------------|--------------------------------|
| Project Nr.                                 |               |                 |                                |
| <b>334-08-22HW Log cabin 450x530cm 44mm</b> |               |                 |                                |
| Dealer                                      | -             | ROOF PARTS      |                                |
| Dealers references                          | -             | Scale<br>1 : 40 |                                |
|   | <b>Berlin</b> | Drawer          | Sheet Nr.                      |
|   | -             | RB              | TD-3                           |
|   | -             |                 | Date<br>07.12.2022<br>11:11:14 |

## ROOF PART SCHEDULE

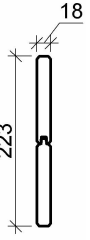
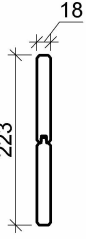
| Type Image  | Keynote  | Description           | Count | Cut Length | Volume               |
|---|----------|-----------------------|-------|------------|----------------------|
|    | CB 18x95 | Cover board           | 2     | 2160       | 0.007 m <sup>3</sup> |
|    | CB 18x95 | Cover board           | 2     | 3715       | 0.013 m <sup>3</sup> |
|    | RB 18x88 | Roof board 18mm       | 56    | 2110       | 0.184 m <sup>3</sup> |
|    | RB 18x88 | Roof board 18mm       | 56    | 3665       | 0.320 m <sup>3</sup> |
|    | RS 44x44 | Roof side board 44x44 | 4     | 2430       | 0.019 m <sup>3</sup> |
|   | WB 18mm  | Wind board 18mm       | 2     | 2140       | 0.017 m <sup>3</sup> |
|  | WB 18mm  | Wind board 18mm       | 2     | 3695       | 0.029 m <sup>3</sup> |
| 0.590 m <sup>3</sup>  |          |                       |       |            |                      |

Notes:

1. All wind boards are provided longer, for precise cut on site.

## SCREW AND FIXING SCHEDULE

| Keynote | Length | Description | Count | Model                         |
|---------|--------|-------------|-------|-------------------------------|
| 3.5x45  | 45     | Screw       | 818   | Roof board screws             |
| 5x100   | 100    | Screw       | 4     | Post connection to wall plate |
| 5x120   | 120    | Screw       | 54    | Gable wall screws             |
| 6x200   | 200    | Screw       | 13    | Roof joist screws             |
| WP      | 50     |             | 111   | Wood Pin                      |

## ROOF JOISTS DETAIL VIEWS

Front view

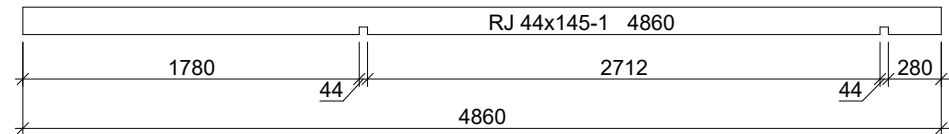

Front view

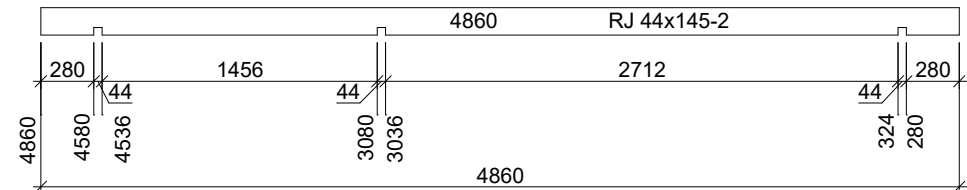

## ROOF JOIST SCHEDULE

| Keynote     | Description       | Count | Cut Length | Volume               |
|-------------|-------------------|-------|------------|----------------------|
| RJ 44x145-1 | Roof joist 44x145 | 5     | 4860       | 0.154 m <sup>3</sup> |
| RJ 44x145-2 | Roof joist 44x145 | 1     | 4860       | 0.031 m <sup>3</sup> |

0.185 m<sup>3</sup>

Project Nr.

**334-08-22HW Log cabin 450x530cm 44mm**

Dealer

- ROOF PART SCHEDULE

Scale

1 : 40

Dealers

references

- Berlin

Drawer

Sheet Nr.

Date

- RB

TD-4

07.12.2022  
11:11:15