

FRONT VIEW

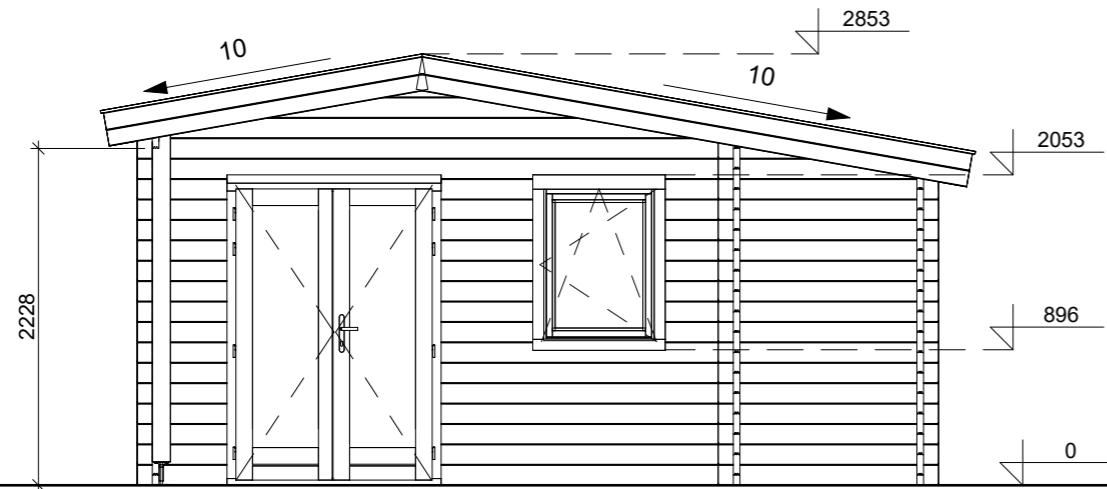

LEFT SIDE VIEW

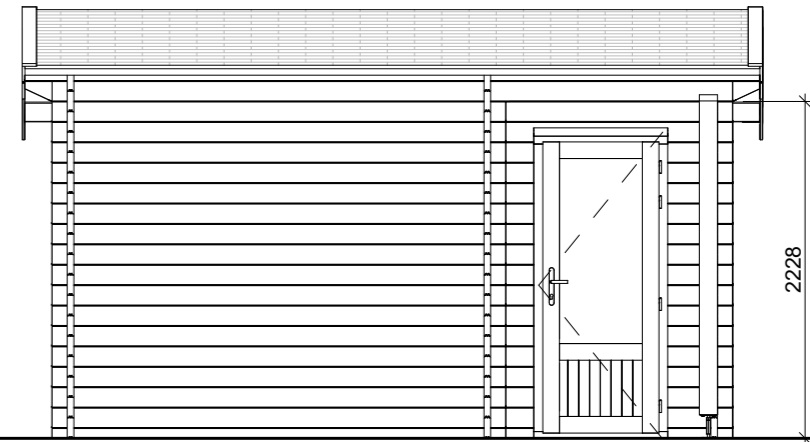

SECTION 1-1

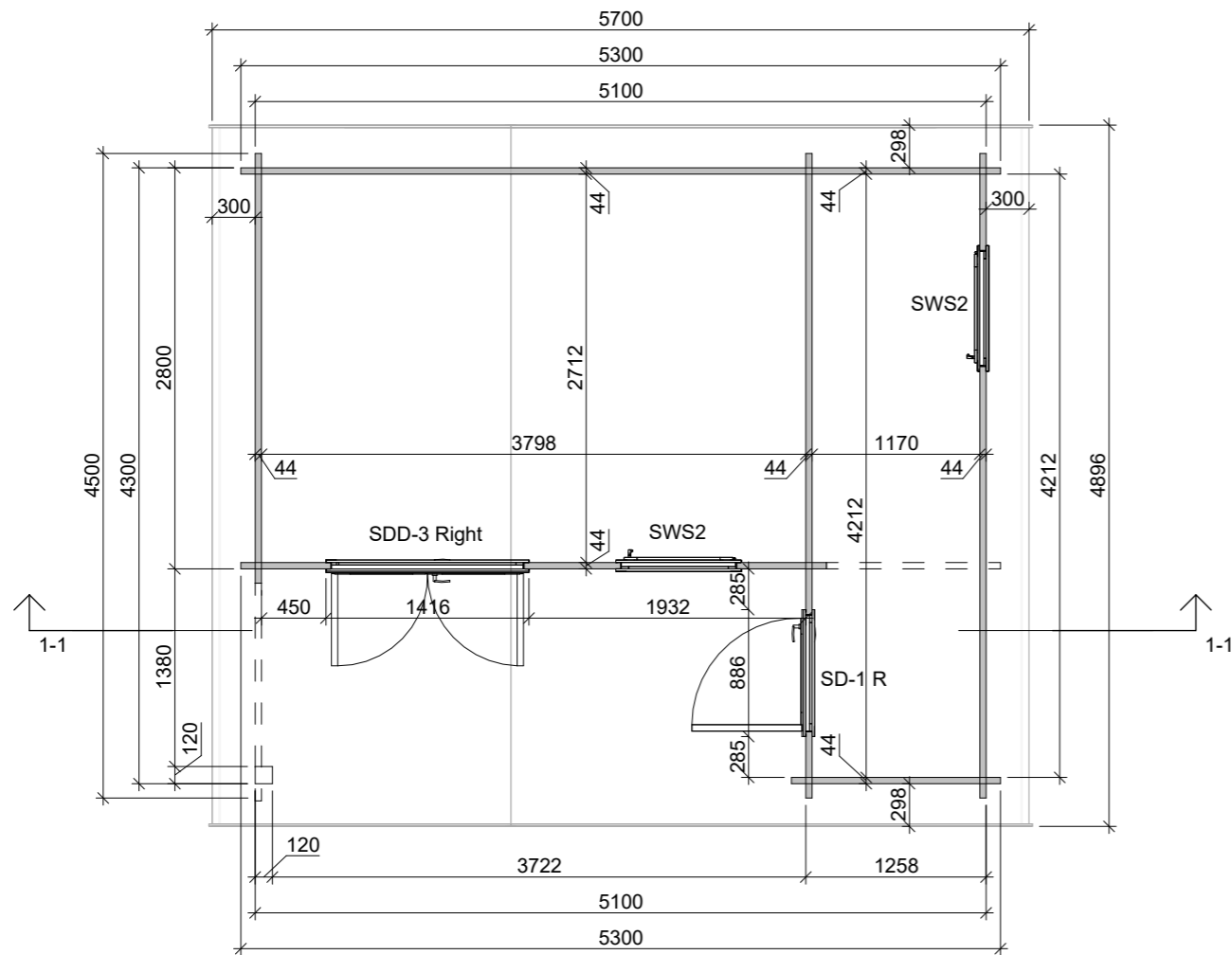
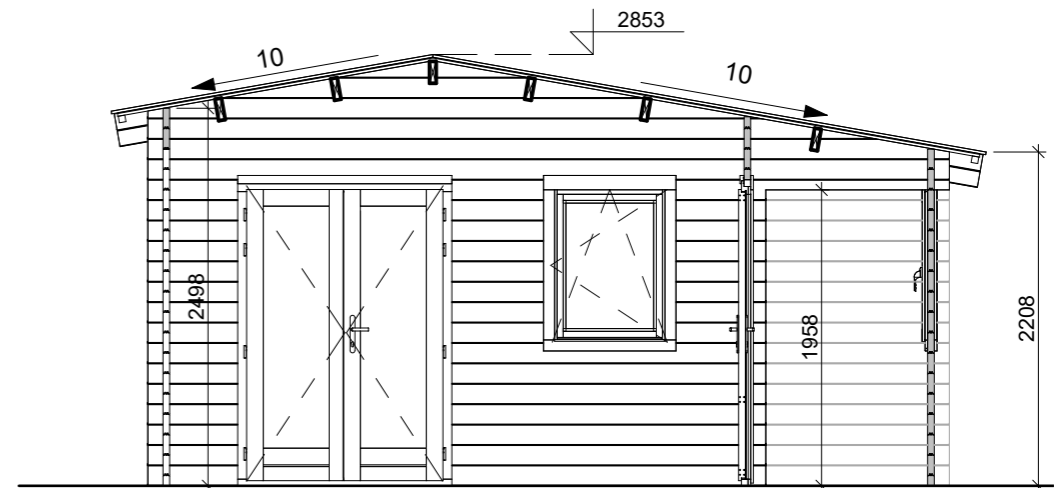

FLOOR PLAN

Project Nr. 334-08-22HW Log cabin 450x530cm 44mm				
ARCHITECTURE DRAWINGS	Scale	Drawer	Sheet Nr.	Date
	1 : 50	RB	AR - 1	03.11.2022 09:16:59

REAR VIEW

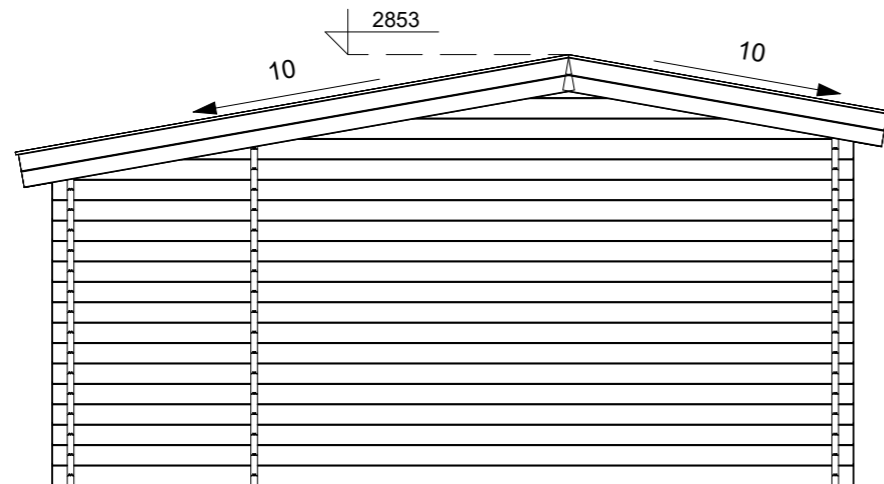

RIGHT SIDE VIEW

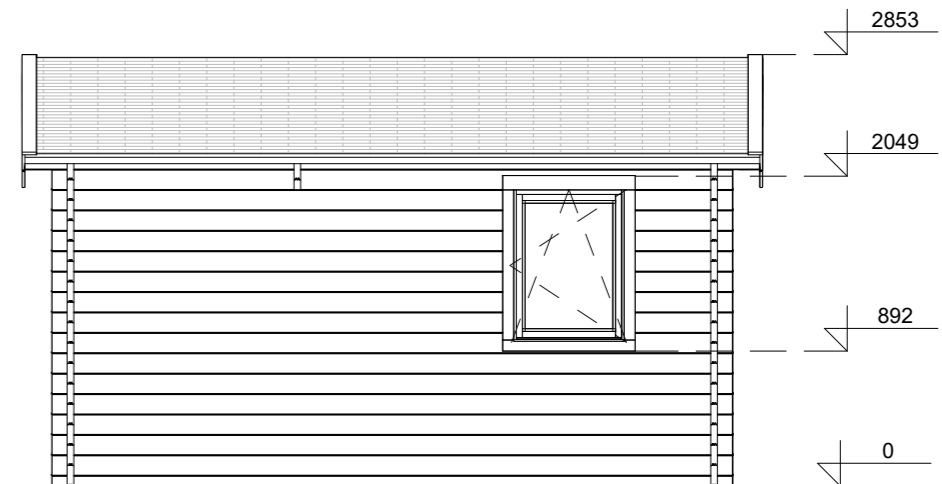

3D VIEW

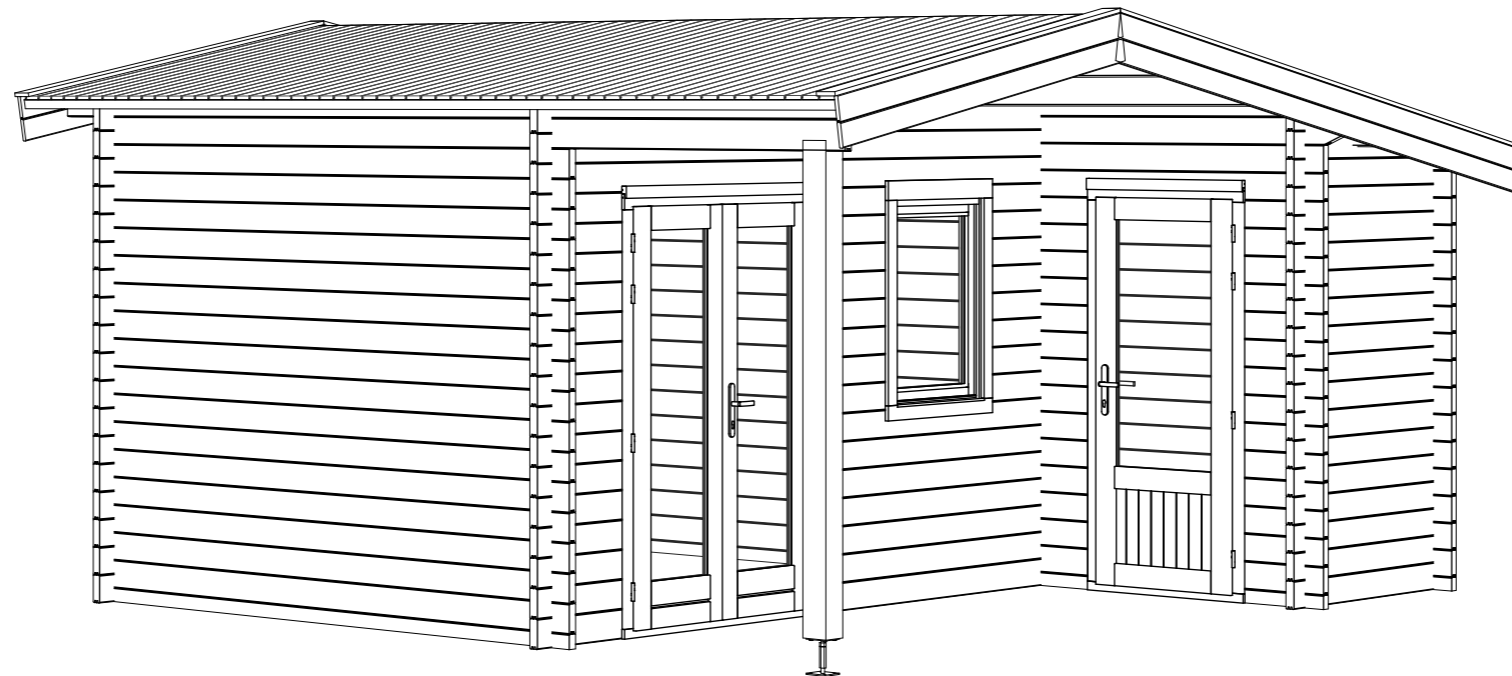



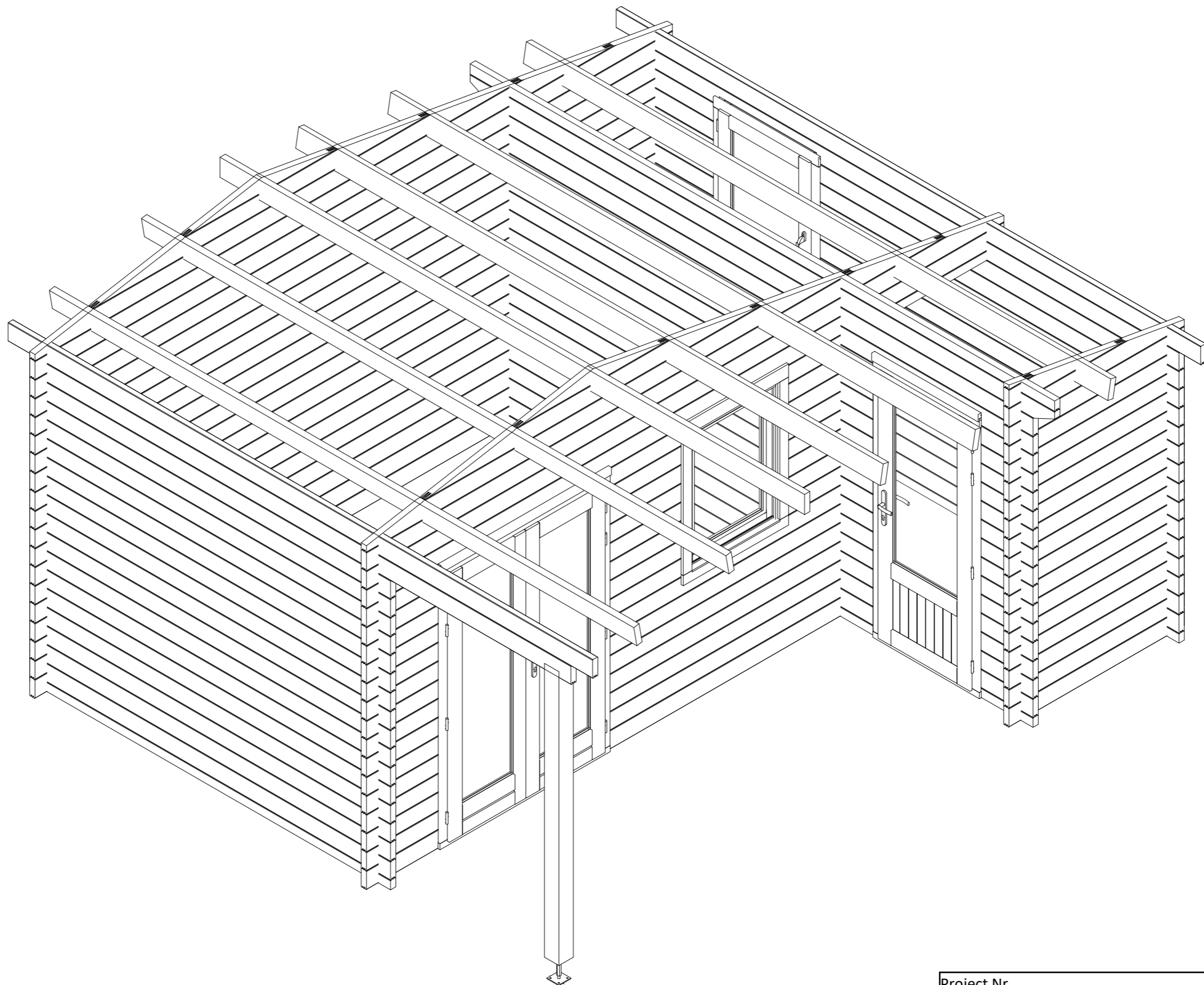

Project Nr. **334-08-22HW Log cabin 450x530cm 44mm**

ARCHITECTURE DRAWINGS	Scale	Drawer	Sheet Nr.	Date
	1 : 50	RB	AR - 2	03.11.2022 09:16:59

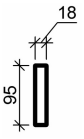

Project Nr.		334-08-22HW Log cabin 450x530cm 44mm		
ARCHITECTURE DRAWINGS	Scale	Drawer	Sheet Nr.	Date
		RB	AR - 3	03.11.2022 09:17:00

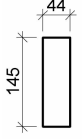
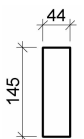
ROOF PART SPECIFICATION

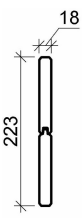
Type Image	Keynote	Description
	CB 18x95	Cover board
	RB 18x88	Roof board 18mm
	RJ 44x145-1	Roof joist 44x145
	RJ 44x145-2	Roof joist 44x145
	RS 44x44	Roof side board 44x44
	WB 18mm	Wind board 18mm

FLOOR PART SPECIFICATION

Type Image	Keynote	Description
------------	---------	-------------

DOOR SCHEDULE

Keynote	Count
SD-1 R	1
SDD-3 Right	1
	2

WINDOW SCHEDULE

Keynote	Count
SWS2	2
	2

ROOF SCHEDULE

Roof type	Area
Apex	28 m ²
	28 m ²

FLOOR SCHEDULE

Description	Area
-------------	------

Project Nr.

334-08-22HW Log cabin 450x530cm 44mm

ARCHITECTURE
DRAWINGS

Scale

Drawer

Sheet Nr.

Date

RB

AR - 4

03.11.2022
09:17:00

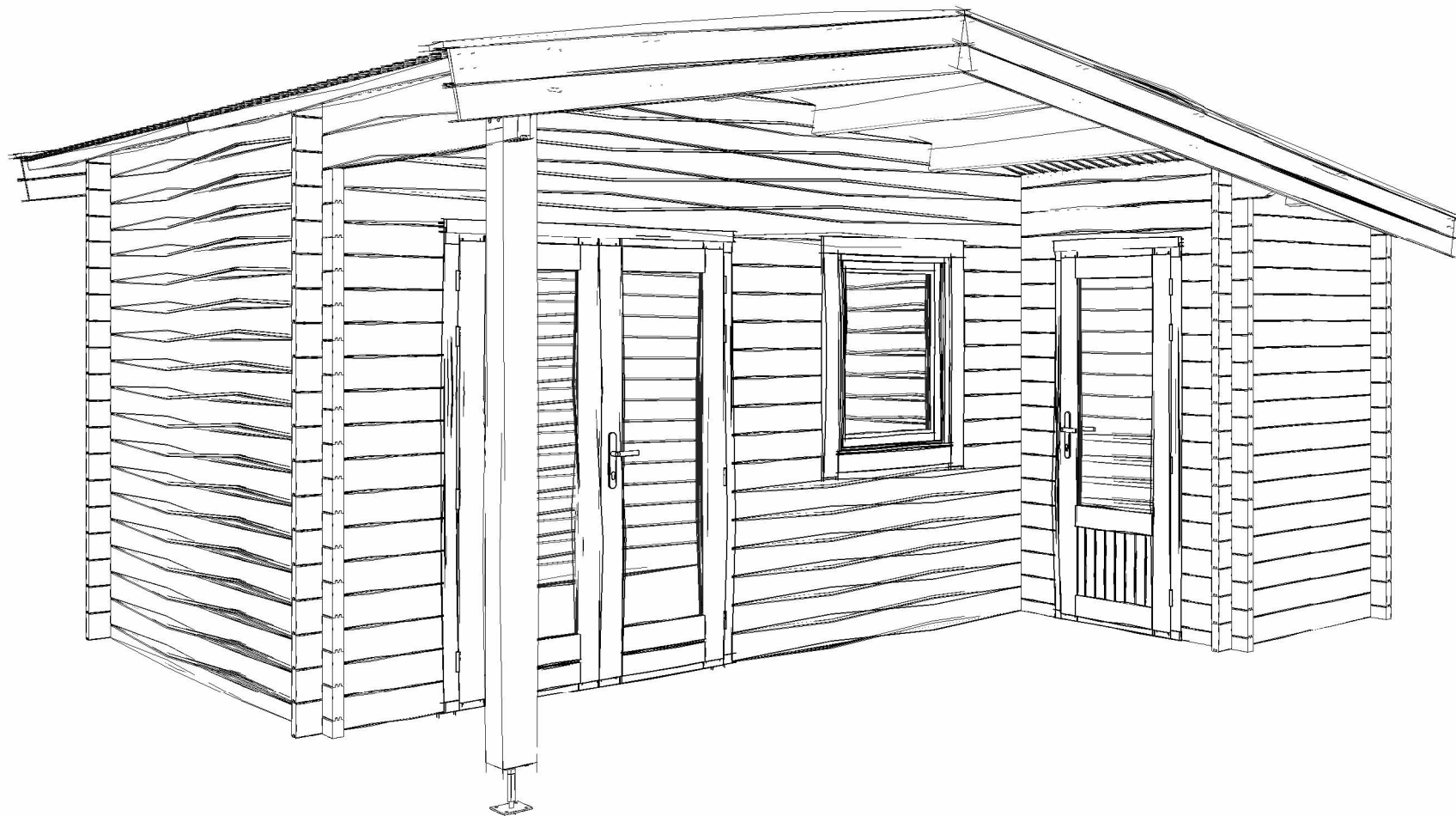

***334-08-22HW Log cabin
450x530cm 44mm***

-

Project Nr.		334-08-22HW Log cabin 450x530cm 44mm		
Dealer	-	COVER PAGE		Scale
Dealers references	-			Date
	Berlin	Drawer	Sheet Nr.	
	-	RB	TD	25.11.2022 13:21:52

Wall logs

Log thickness	Log height	Cut Length	Count
44 mm	135 mm	1265	1
44 mm	135 mm	2796	1
44 mm	135 mm	4048	1
44 mm	135 mm	4813	1
44 mm	135 mm	5300	17

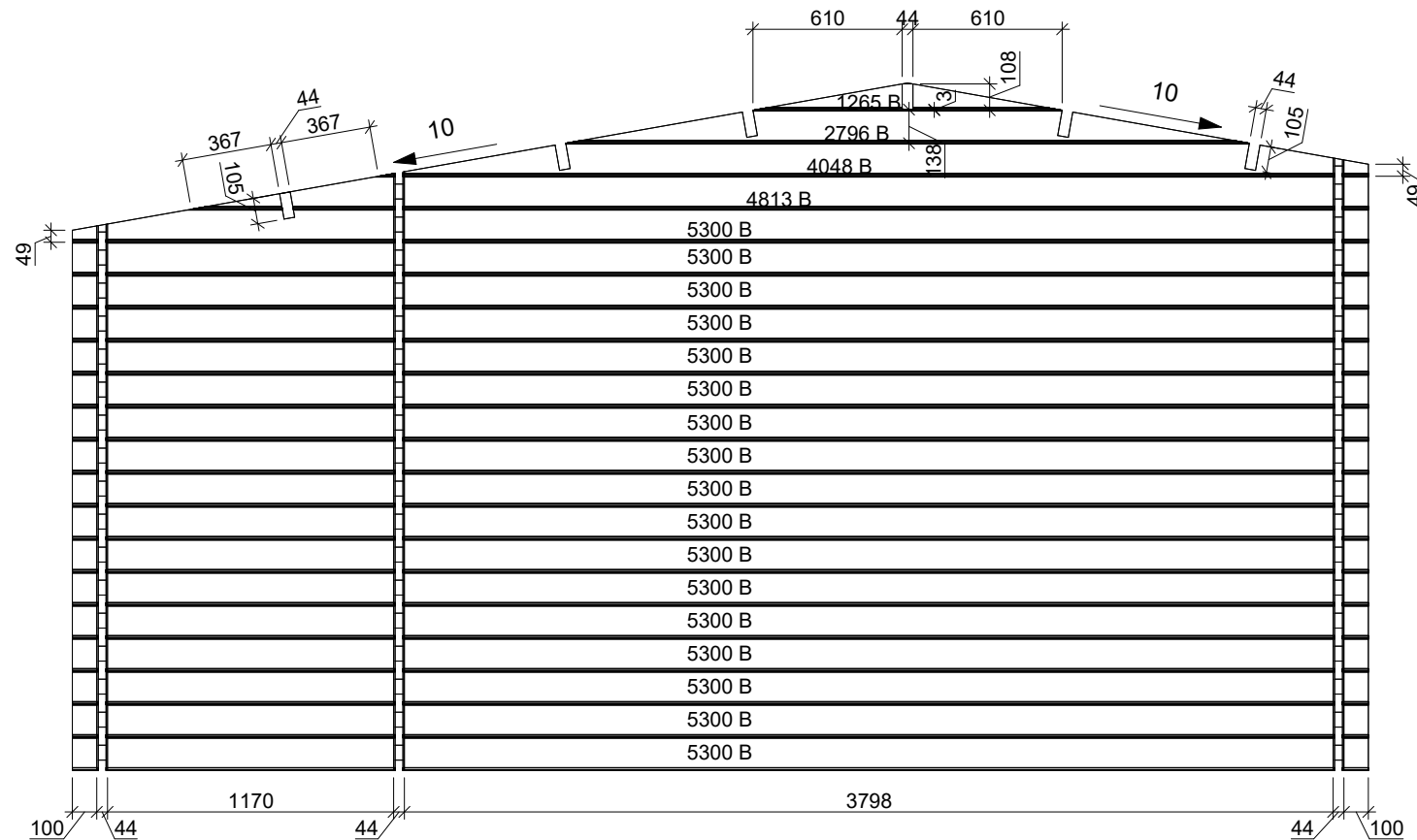

Project Nr.			
334-08-22HW Log cabin 450x530cm 44mm			
Dealer	-	Wall logs	
Dealers references	-		
		Scale	1 : 30
		Drawer	Sheet Nr.
	Berlin	Date	25.11.2022 13:21:53
	-	RB	WALL - B

Wall logs

Log thickness	Log height	Cut Length	Count
44 mm	135 mm	709	7
44 mm	135 mm	2981	7
44 mm	135 mm	4500	9
44 mm	135 mm	4860	1

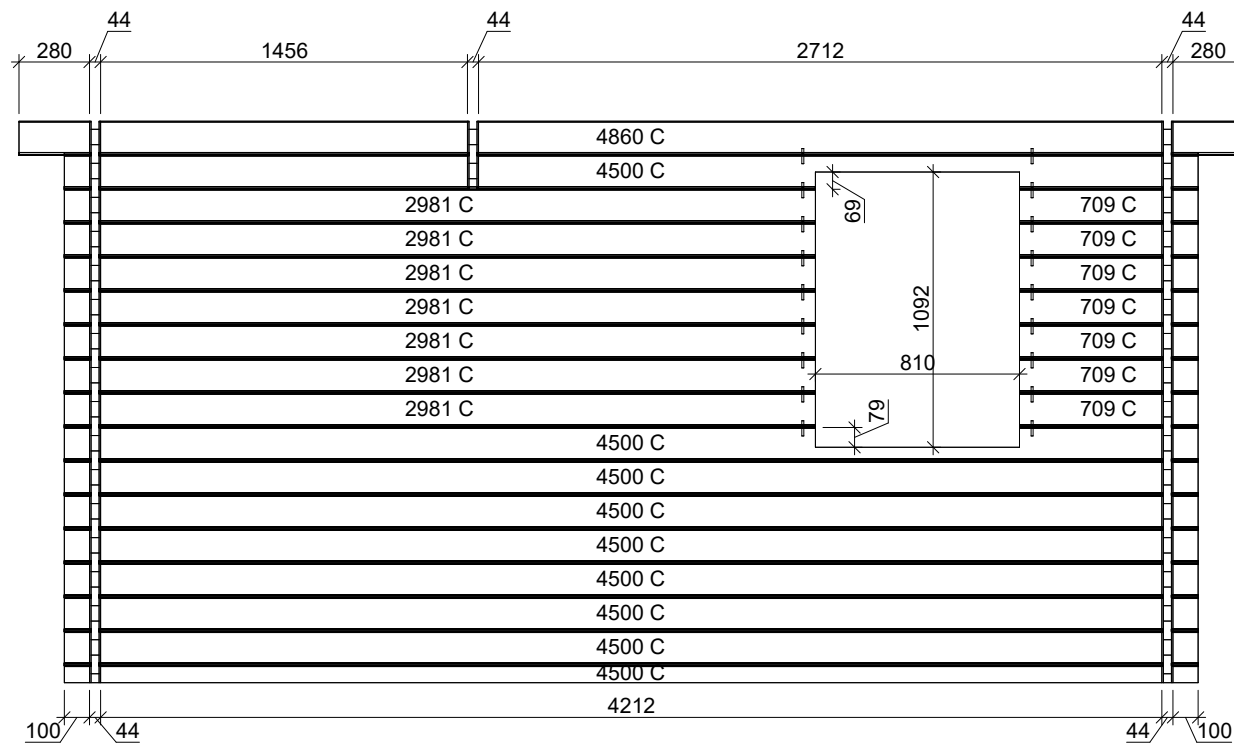

Project Nr.			
334-08-22HW Log cabin 450x530cm 44mm			
Dealer	-	Wall logs	
Dealers references	-	Scale	1 : 30
	Berlin	Drawer	Sheet Nr.
	-	RB	WALL - C
	-	Date	25.11.2022 13:21:53

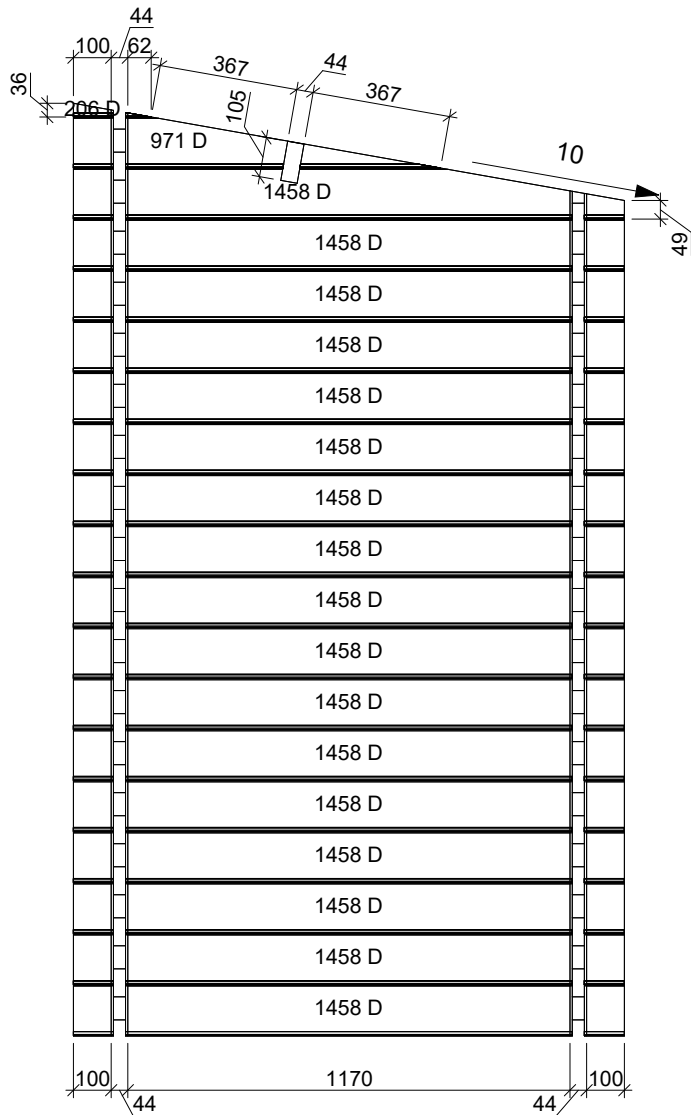

Wall logs			
Log thickness	Log height	Cut Length	Count
44 mm	135 mm	206	1
44 mm	135 mm	971	1
44 mm	135 mm	1458	17

Project Nr.			
334-08-22HW Log cabin 450x530cm 44mm			
Dealer	-	Scale	
Dealers references	-	1 : 20	
	Berlin	Drawer	Sheet Nr.
	-	RB	WALL - D
	-		Date
	-		25.11.2022 13:21:53

LOG WALL NUMBERING

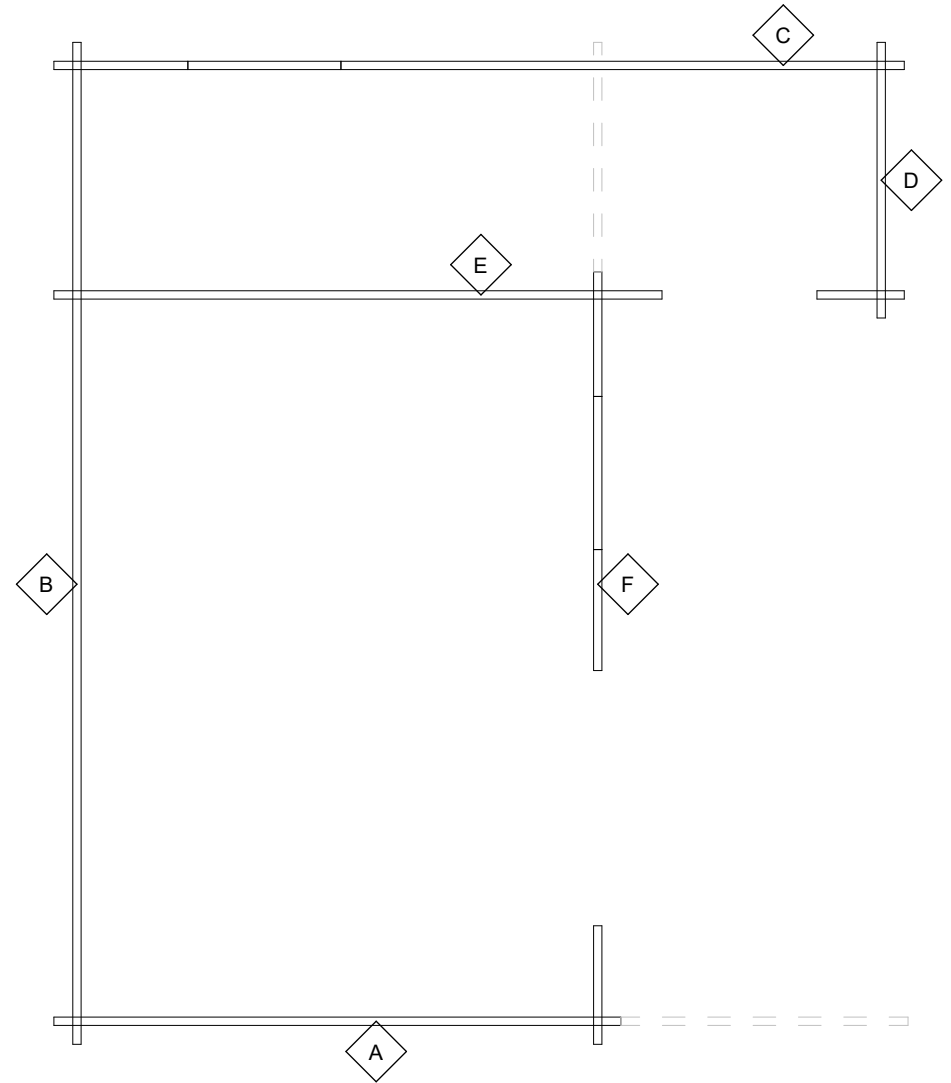

LOG WALL 3D VIEW

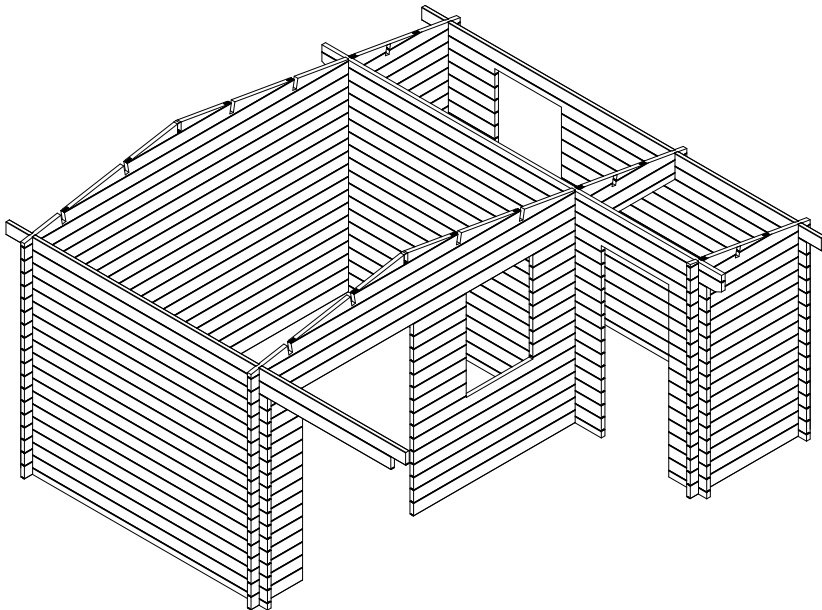

Project Nr.			
334-08-22HW Log cabin 450x530cm 44mm			
Dealer	-	LOG WALL POSITIONS	Scale
Dealers references	-		1 : 40
	Berlin	Drawer	Sheet Nr.
	-	RB	TD-1
	-		Date
	-		25.11.2022 13:21:55

Post detail views

Top view

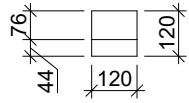

Front view

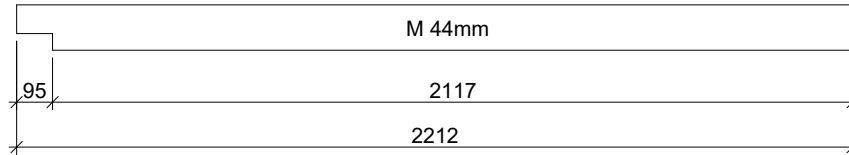

POST SCHEDULE

Keynote	Description	Length	Count	Volume
M 44mm	Post 120x120	2212	1	0.031 m ³
				0.031 m ³

Project Nr.				334-08-22HW Log cabin 450x530cm 44mm			
Dealer		-		POST SCHEDULES AND DETAIL VIEWS		Scale	
Dealers references		-				1 : 20	
		Berlin		Drawer		Sheet Nr.	
		-		RB		TD-2	
						25.11.2022 13:21:55	

ROOF PARTS PLAN

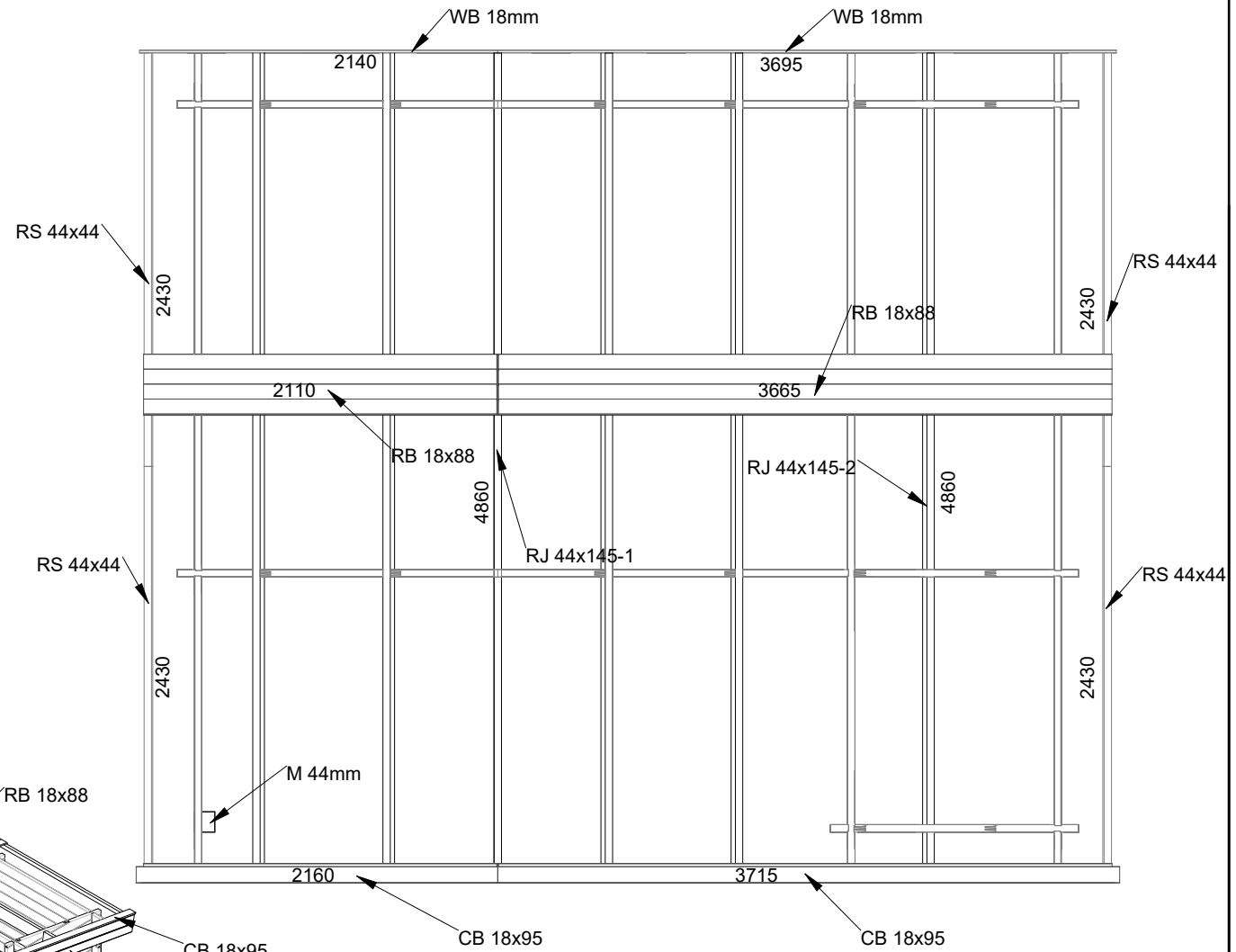



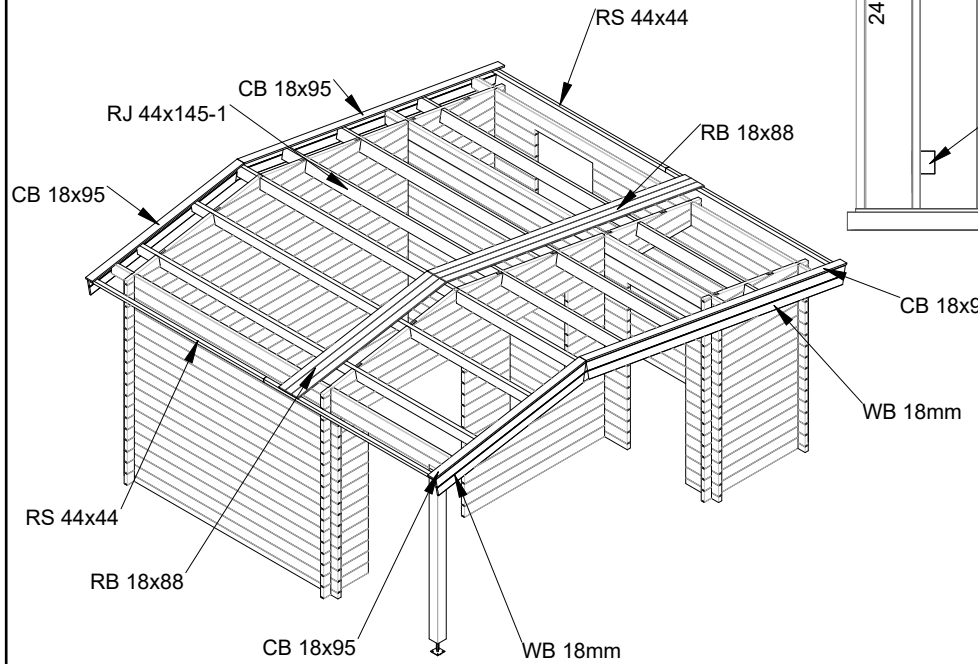

ROOF PARTS ASSEMBLY VIEW

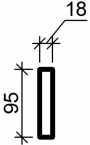
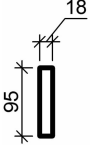

Project Nr.			
334-08-22HW Log cabin 450x530cm 44mm			
Dealer	-	ROOF PARTS	
Dealers references	-	Scale	1 : 40
		Drawer	Sheet Nr.
	Berlin	RB	TD-3
	-	Date	25.11.2022 13:21:57

ROOF PART SCHEDULE

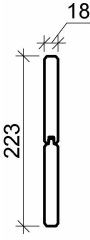
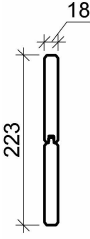
Type Image	Keynote	Description	Count	Cut Length	Volume
	CB 18x95	Cover board	2	2160	0.007 m ³
	CB 18x95	Cover board	2	3715	0.013 m ³
	RB 18x88	Roof board 18mm	56	2110	0.184 m ³
	RB 18x88	Roof board 18mm	56	3665	0.320 m ³
	RS 44x44	Roof side board 44x44	4	2430	0.019 m ³
	WB 18mm	Wind board 18mm	2	2140	0.017 m ³
	WB 18mm	Wind board 18mm	2	3695	0.029 m ³
0.590 m³					

Notes:

1. All wind boards are provided longer, for precise cut on site.

SCREW AND FIXING SCHEDULE

Keynote	Length	Description	Count	Model
3.5x45	45	Screw	818	Roof board screws
5x100	100	Screw	4	Post connection to wall plate
5x120	120	Screw	54	Gable wall screws
6x200	200	Screw	13	Roof joist screws
WP	50		111	Wood Pin

ROOF JOISTS DETAIL VIEWS

Front view

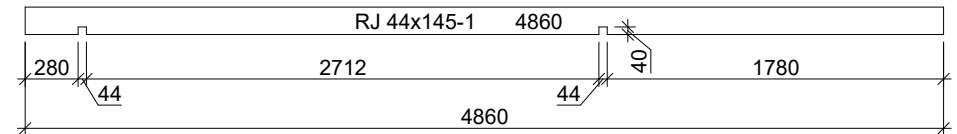

Front view

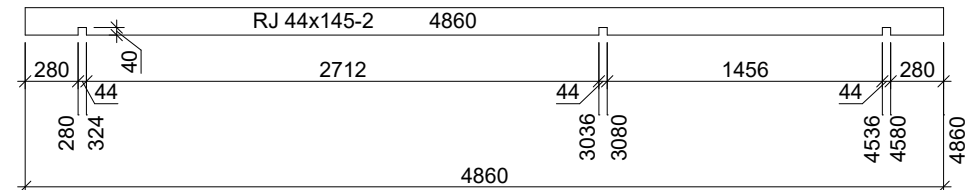

ROOF JOIST SCHEDULE

Keynote	Description	Count	Cut Length	Volume
RJ 44x145-1	Roof joist 44x145	5	4860	0.154 m ³
RJ 44x145-2	Roof joist 44x145	1	4860	0.031 m ³

0.185 m³

Project Nr.

334-08-22HW Log cabin 450x530cm 44mm

Dealer

- ROOF PART SCHEDULE

Scale

1 : 40

Dealers references

- Drawer Sheet Nr.

Date

Berlin

- RB TD-4

25.11.2022
13:21:57